

# **OPENING THE DOOR ON HARDWARE**

OUR HARDWARE BRANDS

JOSEPH GILES

ARMAC MARTIN

**PERRIN & ROWE**<sup>®</sup>  
MAYFAIR LONDON

**OXFORD**  
DECORATIVE GRILLES

We offer boutique hardware discernably sourced from around the UK.

We believe that hardware is the perfect way to offer luxurious touchpoints throughout a project.

Here is a basic guide to unravel the complex world of hardware so you can begin the conversation with your clients and our dedicated hardware specification team.

VISIT OUR WEBSITE  
TO VIEW OUR COLLECTIONS

# IDENTIFYING DOORS

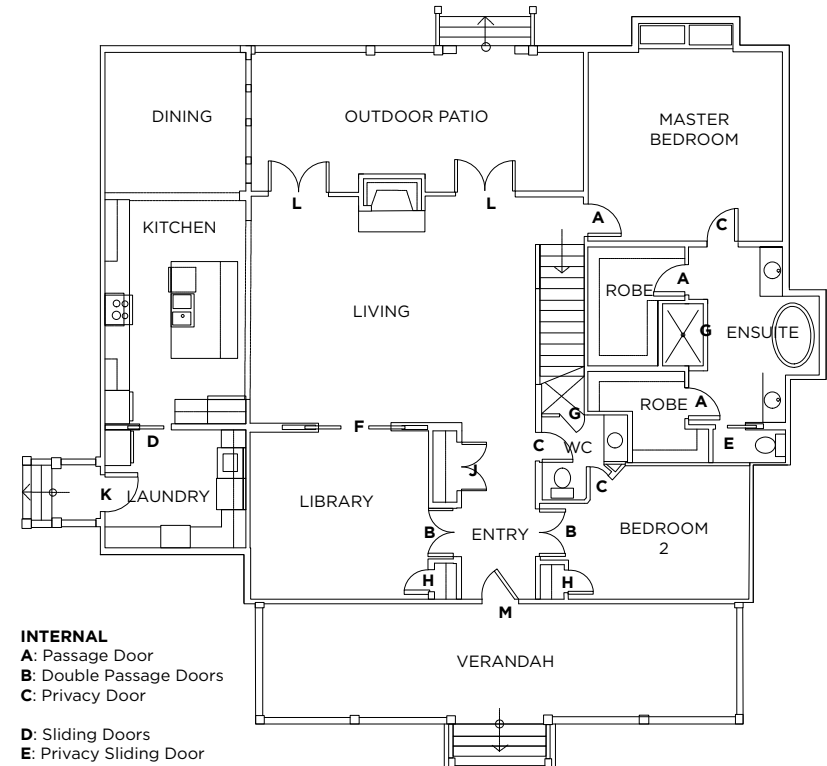

## INTERNAL

- A: Passage Door
- B: Double Passage Doors
- C: Privacy Door

- D: Sliding Doors
- E: Privacy Sliding Door
- F: Double Sliding Doors

- G: Shower Door
- H: Storage Door
- J: Double Storage Doors

## EXTERNAL

- K: Single External Door
- L: Double External Doors
- M: Main External Door

# DOOR TYPES

## STEEL FRAMED DOOR

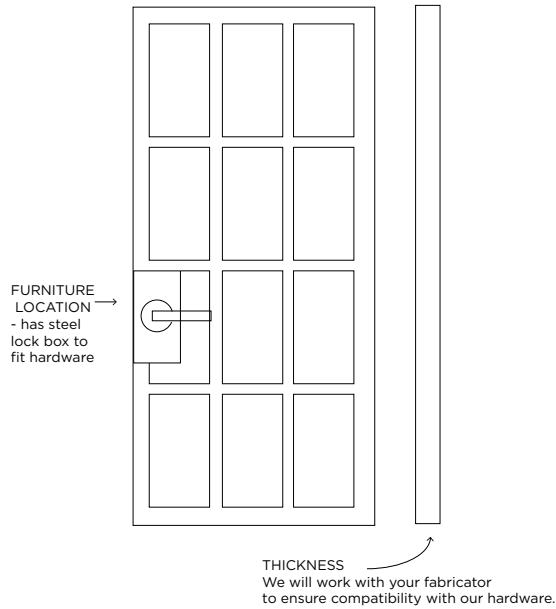

## GLAZED DOOR

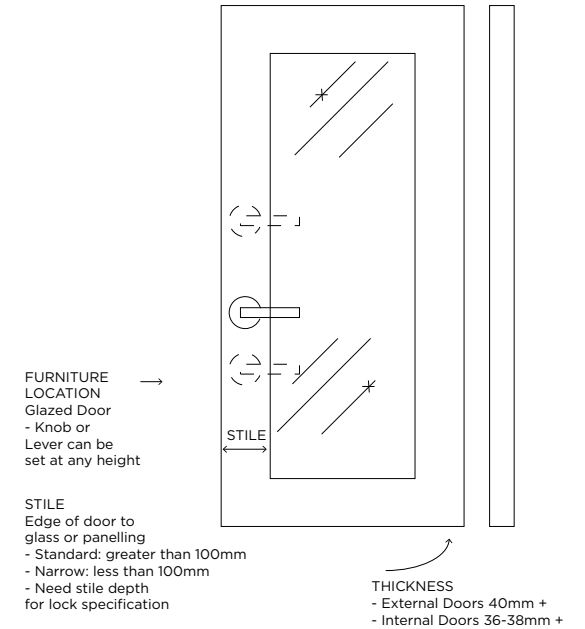

## FLUSH PANEL DOOR HOLLOW CORE, SEMI-SOLID, SOLID

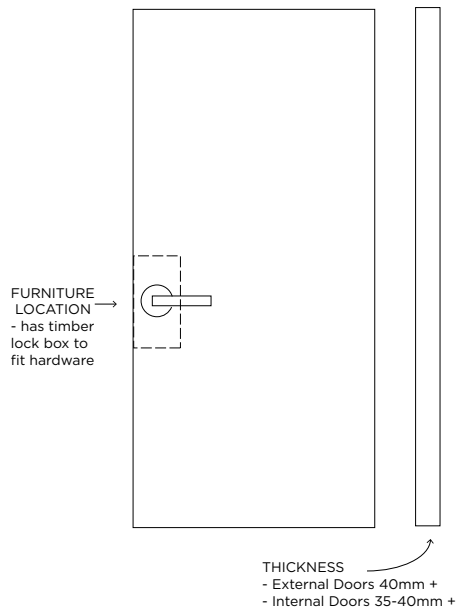
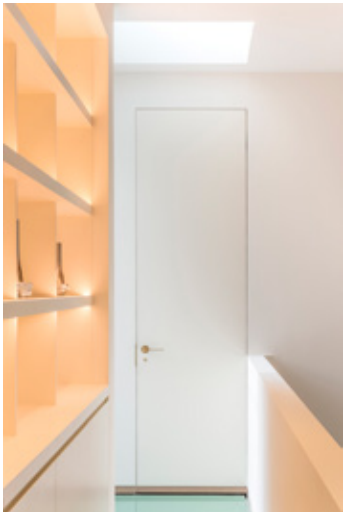

## PANELLED DOOR SOLID TIMBER OR MDF

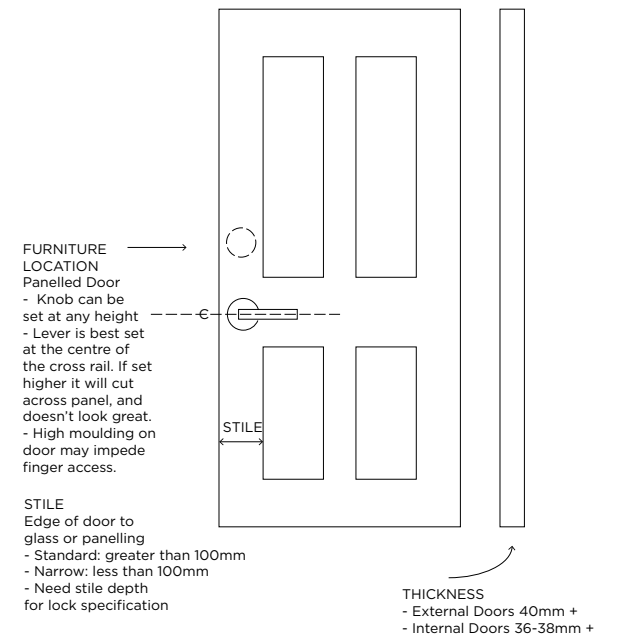
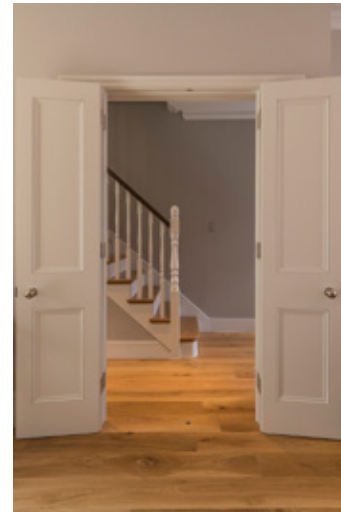

# SPECIFYING PASSAGE DOORS:

A passage door is any internal hinged door that doesn't lock.

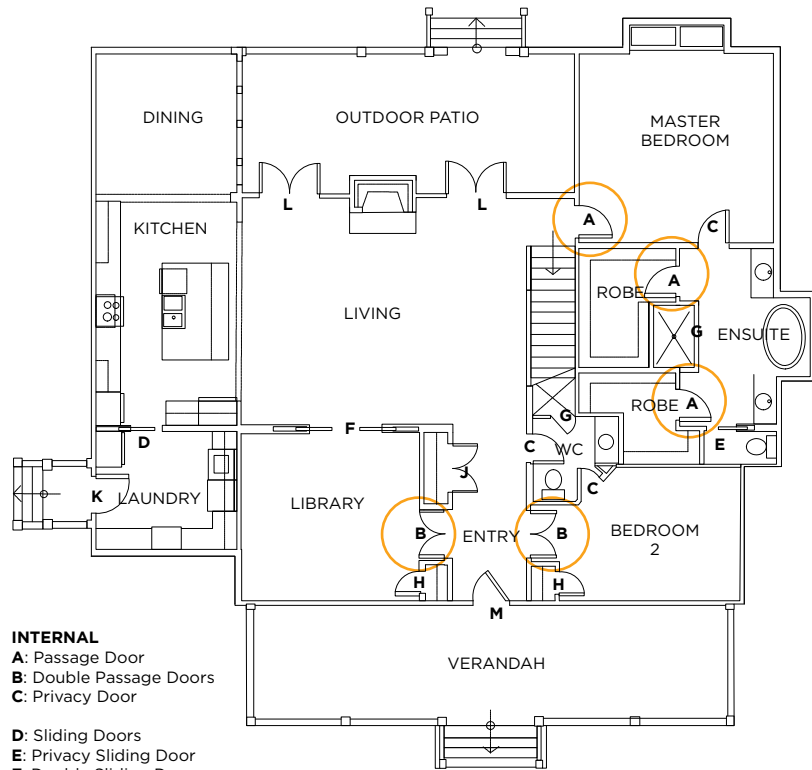

## INTERNAL

- A: Passage Door
- B: Double Passage Doors
- C: Privacy Door
- D: Sliding Doors
- E: Privacy Sliding Door
- F: Double Sliding Doors
- G: Shower Door
- H: Storage Door
- J: Double Storage Doors

## EXTERNAL

- K: Single External Door
- L: Double External Doors
- M: Main External Door

## CONSIDERATIONS

- How many passage doors? (Bedroom, walk-in robe, hallway etc)
- Do you want premium latches?
- Are hinges required?
- Are door stops required?

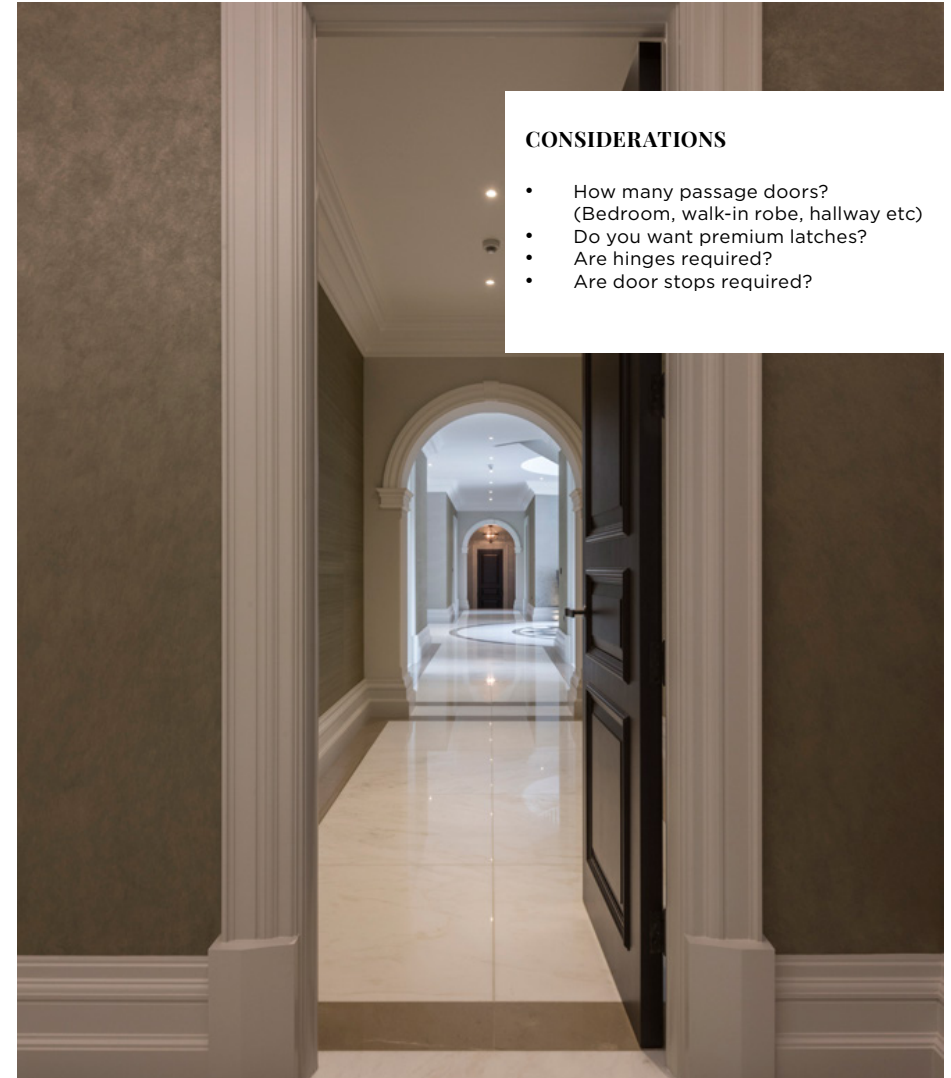

## SPECIFY THE FOLLOWING ITEMS:

DOOR KNOB

or DOOR LEVER



+ INTERNAL LATCH (PREMIUM or RETROFIT option - see next page)

# PASSAGE - PREMIUM OPTION

These are the main mortice 'non-locking' latch types:

Mortice means "recessed into the edge of the door"



## Orange body latch LA1155

- premium offering
- highest quality brass & steel
- requires lever or knob to operate latch
- minimum recommended door thickness is 35mm
- includes dust box

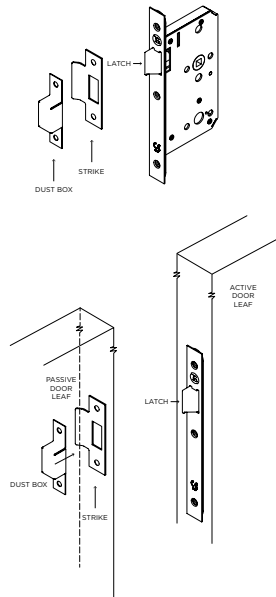

### SPECIFY THE FOLLOWING ITEMS:

LA1155



+ HINGES



+ DOOR STOP



# PASSAGE - RETROFIT OPTION

These are the main mortice 'non-locking' latch types:

Mortice means "recessed into the edge of the door"



## Tubular latch LA1161

- standard offering
- quality brass and steel
- non-locking
- requires lever or knob to operate
- minimum recommended door thickness is 35mm.

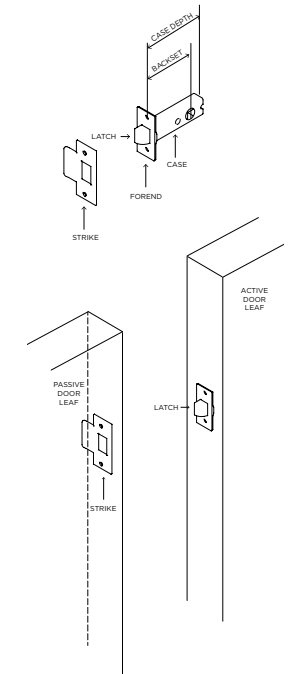

### SPECIFY THE FOLLOWING ITEMS:

LA1161



+ HINGES



+ DOOR STOP



# SPECIFYING PRIVACY DOORS:

A privacy door is any internal hinged door with a lock that is operated by hand rather than a key. A person inside the room can gain privacy by turning the thumb-turn.

If there is an emergency, a coin can be used to open the door from the outside.

Privacy turns and emergency releases are specified as a set to complement the design of the operating knob or lever.

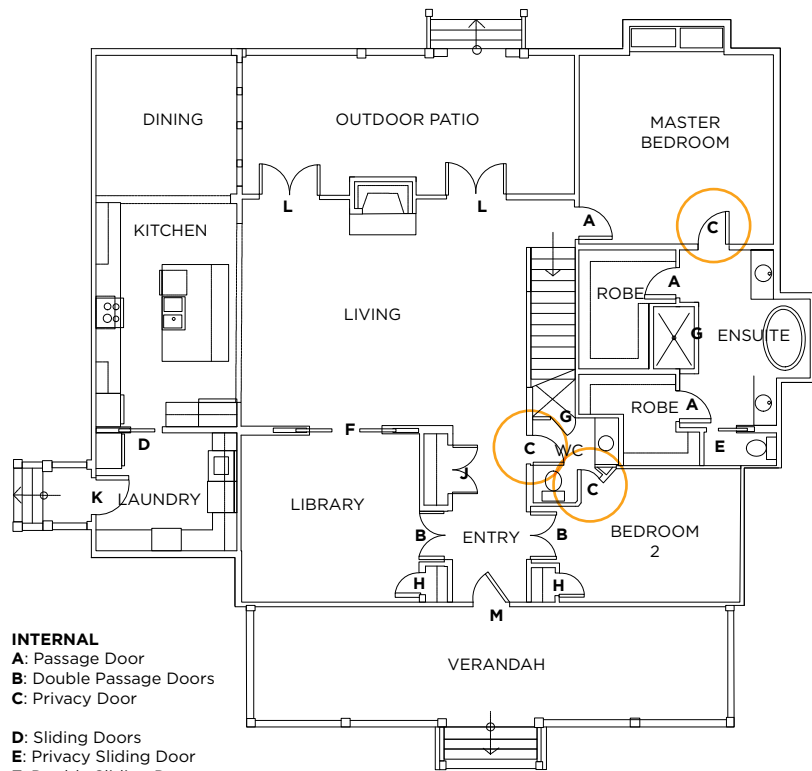

## INTERNAL

- A: Passage Door
- B: Double Passage Doors
- C: Privacy Door

- D: Sliding Doors
- E: Privacy Sliding Door
- F: Double Sliding Doors

- G: Shower Door
- H: Storage Door
- J: Double Storage Doors

## EXTERNAL

- K: Single External Door
- L: Double External Doors
- M: Main External Door



## CONSIDERATIONS

- How many privacy doors?
- (Perhaps bathrooms, offices, master bedrooms)
- Are hinges required?
- Are door stops required?

## SPECIFY THE FOLLOWING ITEMS:

DOOR KNOB



or DOOR LEVER



+ THUMB TURN



+ COIN RELEASE



+ INTERNAL LATCH & BOLT (PREMIUM or RETROFIT option - see next page)



# PRIVACY - PREMIUM OPTION

These are the main mortice lock types:

Mortice means "recessed into the edge of the door"



## Orange Body Lock LA1156

- premium offering
- highest quality brass & steel
- requires lever or knob to operate latch
- requires thumb turn to operate lock bolt (alternatively specify Euro cylinder for keyed locking)
- minimum recommended door thickness is 35mm
- includes dust box

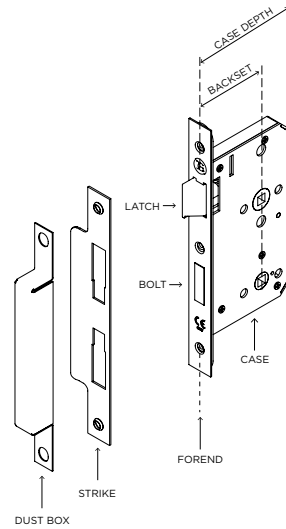

### SPECIFY THE FOLLOWING ITEMS:



# PRIVACY - RETROFIT OPTION



## Tubular latch LA1161

- standard offering
- standard quality brass and steel
- non-locking
- requires lever or knob to operate
- minimum recommended door thickness is 35mm.

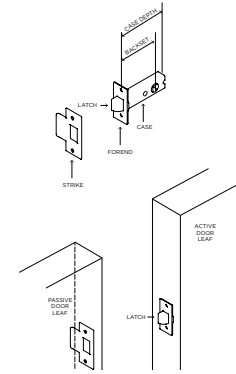

## Tubular Lock LA1017

- standard offering
- standard quality brass and steel
- non-locking
- pair with Tubular Latch
- requires thumb turn to operate lock bolt
- minimum recommended door thickness is 35mm.

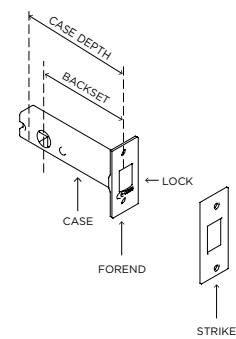

### SPECIFY THE FOLLOWING ITEMS:





# SPECIFYING EXTERNAL DOORS:

External doors are any door that has one side exposed to the exterior of the building.

This type of door will be a hinged or pivot door.

**SINGLE DOORS:** External doors (excluding main entrance door) are generally set up the same in a project as the passage doors, with the addition of a locking function.

**DOUBLE DOORS:** If you have double external doors, usually the doors will be dressed symmetrically, with one lever being functional and operating the lock (active) and the other purely fixed and aesthetic (passive).

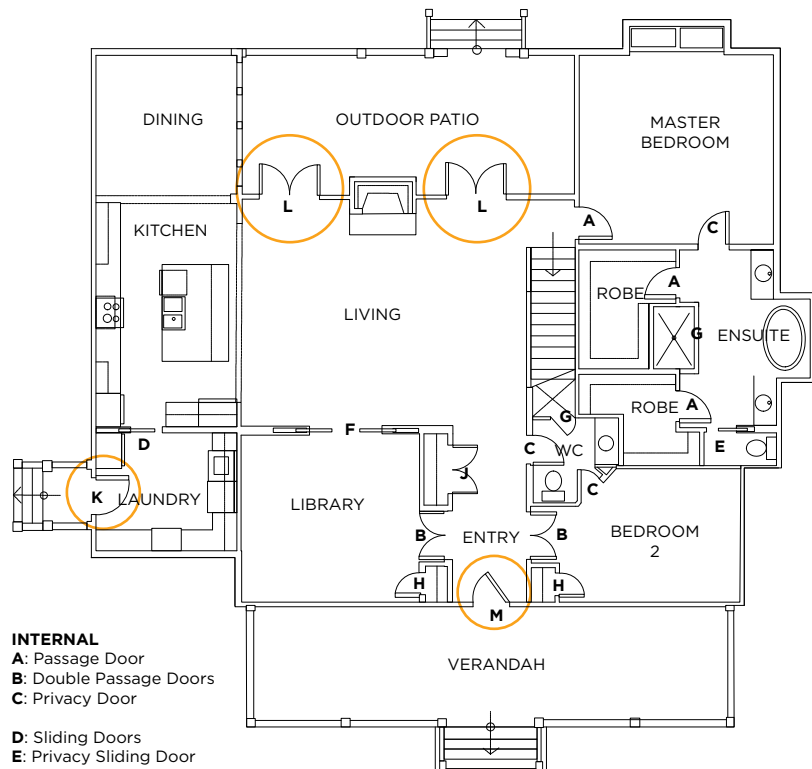

## INTERNAL

- A: Passage Door
- B: Double Passage Doors
- C: Privacy Door

- D: Sliding Doors
- E: Privacy Sliding Door
- F: Double Sliding Doors

- G: Shower Door
- H: Storage Door
- J: Double Storage Doors

## EXTERNAL

- K: Single External Door
- L: Double External Doors
- M: Main External Door

## CONSIDERATIONS

How many altogether?  
Double doors  
Single doors

Are hinges required?  
Are door stops required?  
How do you want the doors to lock?



## SPECIFY THE FOLLOWING ITEMS:

DOOR KNOB



or DOOR LEVER



or DOOR PULL\*



+ ESCUTCHEON



+ INTERNAL LATCH & BOLT - PREMIUM or RETROFIT option (see overleaf)

\*Door Pull works with Nightlatch or Rollercatch only

# ENTRANCE OPTION I - DEADLOCK

These are the main mortice 'keyed' lock types:

Mortice means "recessed into the edge of the door"



## Orange Body EURO LOCK LA1154

- Premium offering
- Highest quality brass & steel
- Requires lever or knob to operate latch on inside only
- Requires key to operate lock bolt via Euro cylinder on outside
- Operate lock with thumb turn on inside.
- Minimum recommended door thickness is 35mm
- includes dust box

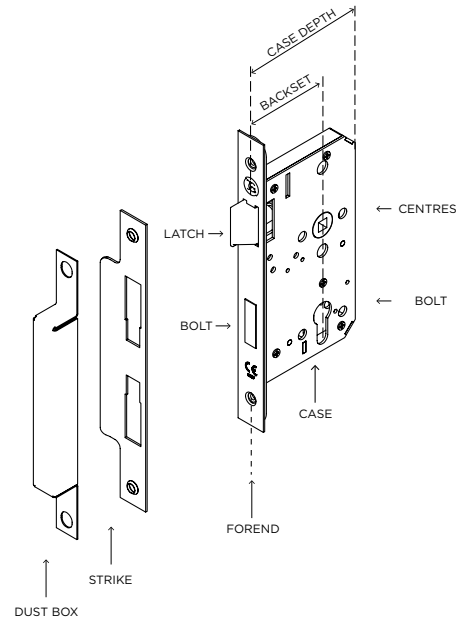

SPECIFY THE FOLLOWING ITEMS:

LA1154



+ HINGES



+ DOOR STOP



# ENTRANCE OPTION II - EASY EXIT

With this type of latch the door is ALWAYS locked from the outside (you'll need a key) and always able to be UNLOCKED from the inside (great to easy-exit, not great for keeping kids inside). If you wish to use this option with kids, we recommend a lockable flyscreen or additional deadlock too.

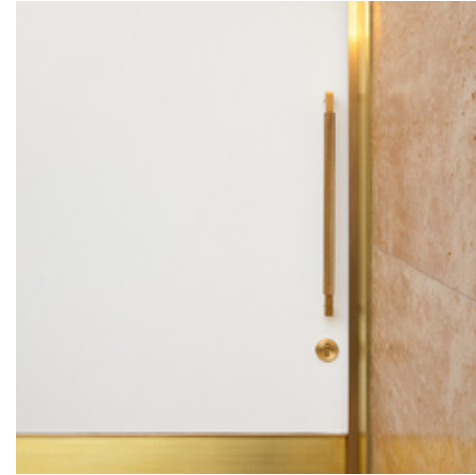

## Orange Body EURO NIGHT LATCH LA1157

- Premium offering
- Highest quality brass & steel
- Minimum recommended door thickness is 35mm
- Includes dust box
- On the outside you only have an escutcheon, with a non-operating handle, lever or knob.
- On the inside you will have a one way operating spindle any decorative hardware is installed in this spindle hole will operate the latch/lock.
- On the inside the cylinder can either have a thumb turn or key function.

EXTERNAL

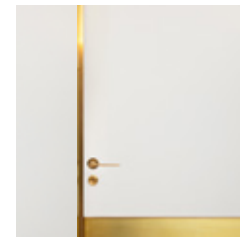

INTERNAL

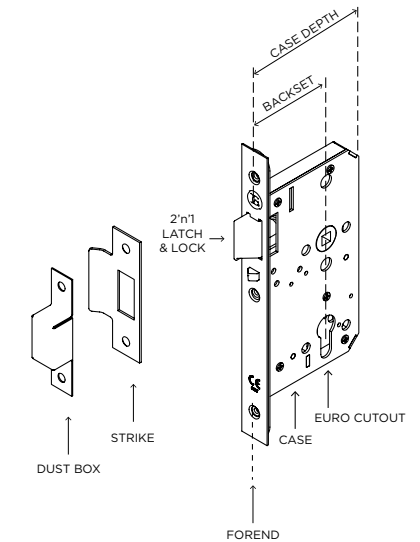

SPECIFY THE FOLLOWING ITEMS:

LA1157



+ HINGES



+ DOOR STOP



# DOUBLE DOWN

You can apply any of the principles of passage, privacy or entrance doors to double doors. The difference is you will need to navigate whether you have Flush or Rebated doors, and you will require door bolts to fix your passive door into the frame.

## DOUBLE FLUSH DOORS

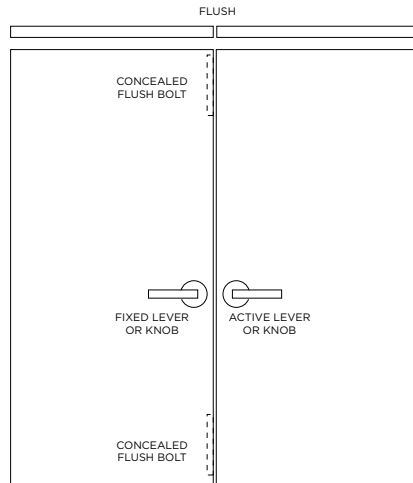
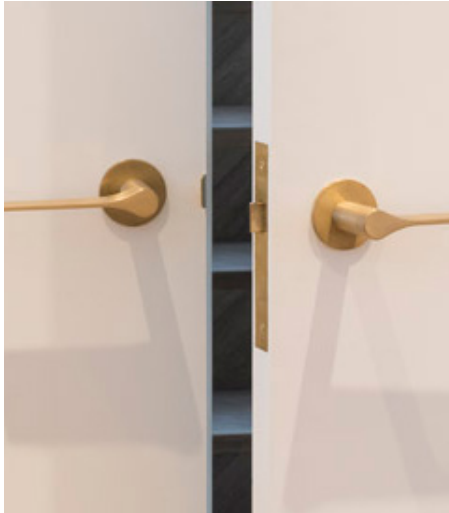

## DOUBLE REBATED DOORS

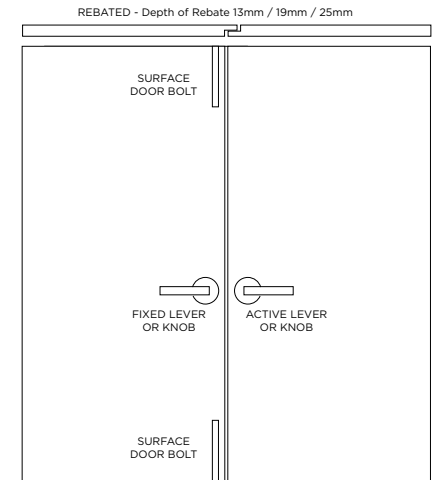

### SPECIFY DOOR BOLTS:

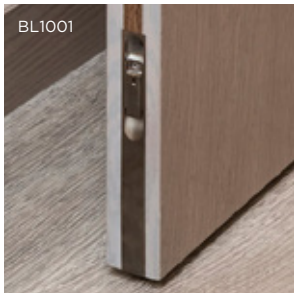

**DOOR BOLT TYPE:** Concealed flush bolt

**REQUIREMENTS:** Two pieces - one at top and one at bottom of passive door. May be different lengths.

**BOLT LENGTHS:** When choosing a flush bolt length, it is important that the finger tab used to operate is situated at a height that is reachable for an adult without any need for steps. We recommend a maximum height of 1800mm for the finger tab from the floor.

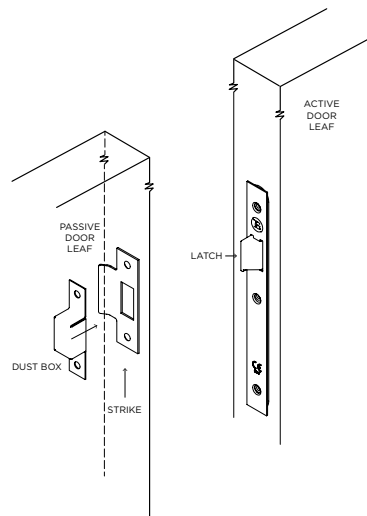

### CONSIDERATIONS

- What is the Door Thickness?
- Are these New or Existing Doors?
- What is the Door Opening Height?

### SPECIFY DOOR BOLTS:

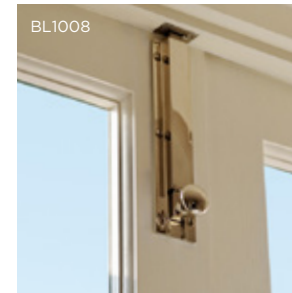

**DOOR BOLT TYPE:** Surface Bolts

**REQUIREMENTS:** Two pieces - one at top and one at bottom of passive door. May be different lengths.

**BOLT LENGTHS:** When choosing a flush bolt length, it is important that the knob used to operate is situated at a height that is reachable for an adult without any need for steps. We recommend a maximum height of 1800mm for the knob from the floor.

### SPECIFY REBATE KIT:

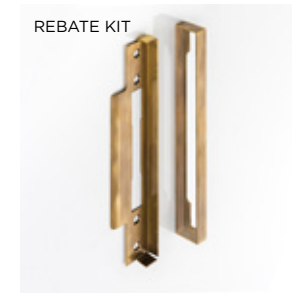

**REBATE KIT TYPE:** Surface Bolts

**REQUIREMENTS:** Must be compatible with the lock or latch and in matching finish.

**DEPTH OF REBATE:** Rebate kits come standard in 13mm depths but can also be special ordered at 19mm or 25mm depths too.

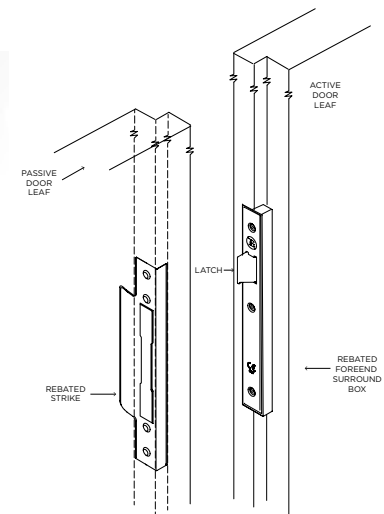

For Cremona Bolts please see our "GUIDE TO CREMONA BOLTS"

# HINGE TYPES

Doors require different hinge layouts depending on the type, application and door weight.



HG1003

**HINGE TYPE:** Butt hinge with exposed screws

**APPLICATION:** Internal or external

**DOOR WEIGHT:**

20kg load capacity with 3 hinges:  
HG1003.01 20kg 75L x 50W x 3mm  
40kg load capacity with 3 hinges:  
HG1003.02 100L x 65W x 3.5mm  
HG1003.03 100L x 75W x 4mm



HG1040

**HINGE TYPE:** Butt hinge with covers

**APPLICATION:** Internal or external

**DOOR WEIGHT:** up to 120kgs



HG1038

**HINGE TYPE:** Butt hinge with exposed screws

**APPLICATION:** Internal or external

**DOOR WEIGHT:** up to 160kgs



HG1010

**HINGE TYPE:** Decorative Butt hinge with exposed screws

**APPLICATION:** Internal or external

**DOOR WEIGHT:** up to 160kgs



HG1011

**HINGE TYPE:** Parliament butt hinge with exposed screws

**APPLICATION:** Internal or external. Projection hinges are usually installed on double doors that are required to fold back against a wall.

**DOOR WEIGHT:**

HG1011.01 has a load capacity of 40kg (3 hinges)  
HG1011.02-04 have a load capacity of 80kg (3 hinges).



PV1009

**HINGE TYPE:** Pivot Hinge

**APPLICATION:** Internal or external double action pivots door that swings in either direction.

**DOOR WEIGHT:** Door leaf weighing up to 80kg

Note: All Joseph Giles hinges come with matching fixings.

# HINGE LAYOUTS

We usually recommend using three hinges for a standard door. Doors taller than 2100mm should mostly be fitted with four hinges.

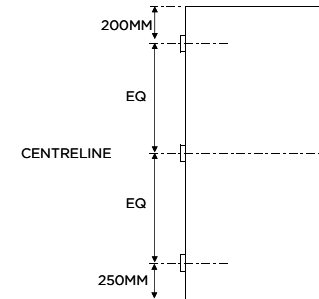

**DOOR TYPE:** Standard Door under 2100mm

**NO. OF HINGES:** 3

**LAYOUT FOR:** Glazed Doors or Doors prone to warping

**DOOR CLOSER:** Suitable for Jamb mounted door closer in middle of the door

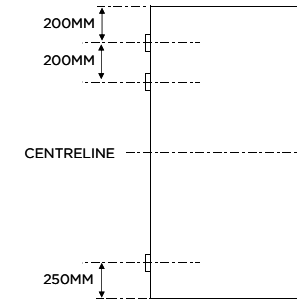

**DOOR TYPE:** Standard Door under 2100mm

**NO. OF HINGES:** 3

**LAYOUT FOR:** Most effective load bearing capability

**DOOR CLOSER:** Suitable for Overhead door closer.

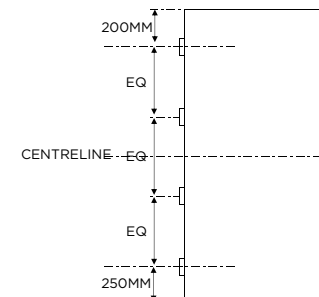

**DOOR TYPE:** Tall Door over 2100mm

**NO. OF HINGES:** 4

**LAYOUT FOR:** Glazed Doors or Doors prone to warping

**DOOR CLOSER:** Suitable for Jamb mounted door closer in middle of the door

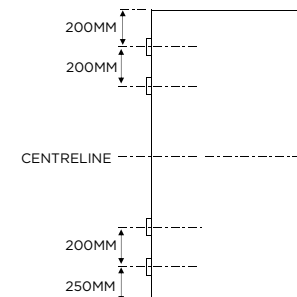

**DOOR TYPE:** Tall Door over 2100mm

**NO. OF HINGES:** 4

**LAYOUT FOR:** Most effective load bearing capability

**DOOR CLOSER:** Suitable for Overhead door closer.

# BUTT HINGES

Butt hinges are standard type of hinges used to create a 90° swinging motion between a door and a door frame.

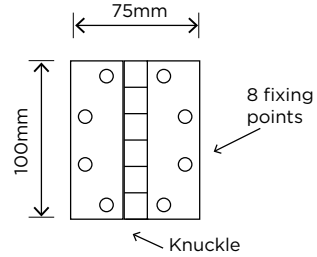

## FIXED PIN

- pin through knuckle cannot be removed
- used on external doors for security

## LOOSE PIN

- pin through knuckle can be removed
- used when builder likes to pull hinge apart when hanging the door

NOTE: We supply 'FIXED PIN' ONLY except when specifically requested.

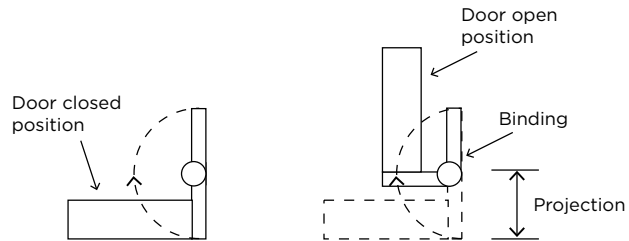

With Standard butt hinges the door only opens at 90°, at that point the door hits the projection. This is called binding.

# PARLIAMENT HINGES

Parliament or Projection 'Broad Butt' hinges are the solution when you require a door to swing out beyond 90° and an obstruction such as an architrave.

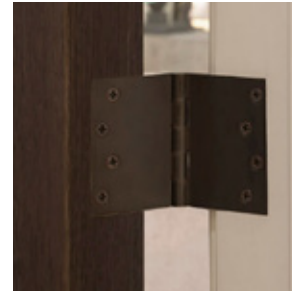
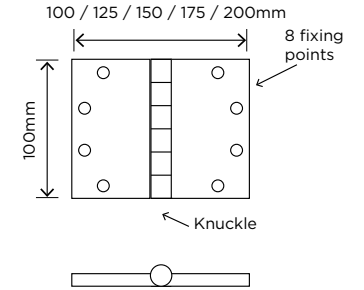

Broad Butt throws the door around the edge of the projection allowing the door to sit back against the wall

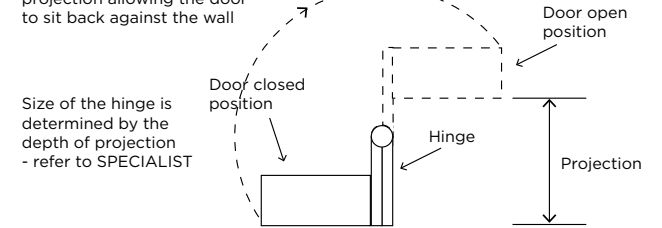

## NUMBER OF HINGES PER DOOR

Default is 3 per door (so 6 for a set of double doors)  
EXCEPT when a door is particularly large or heavy - refer to SPECIALIST



# SPECIFYING STORAGE DOORS:

A storage door is any internal hinged door that doesn't lock and is only used from the outside. Open the door with a fixed knob, lever or flush pull to the outside of the door teamed with a concealed magnetic catch or roller catch.

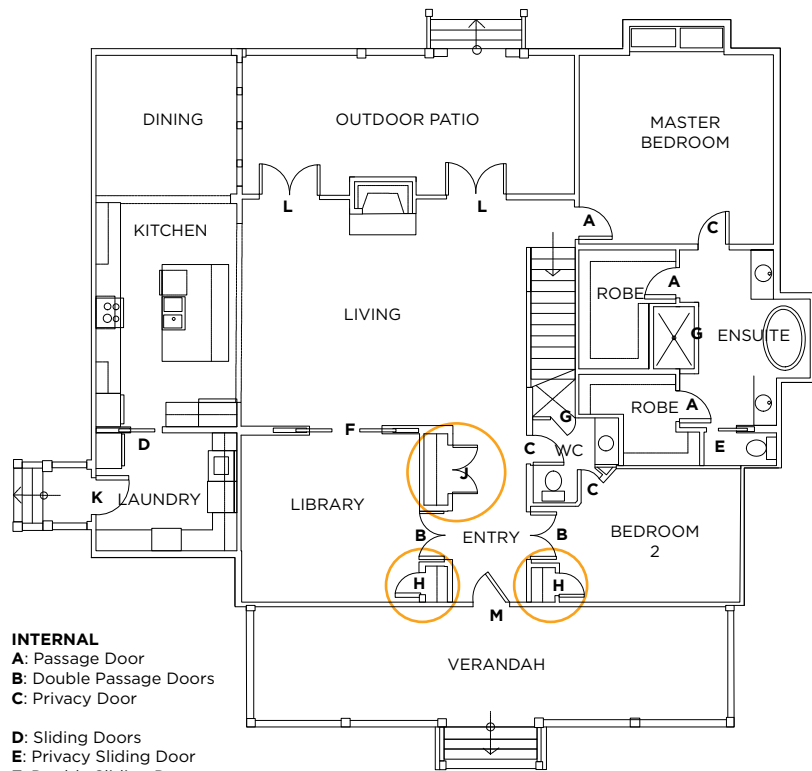

## INTERNAL

- A: Passage Door
- B: Double Passage Doors
- C: Privacy Door

- D: Sliding Doors
- E: Privacy Sliding Door
- F: Double Sliding Doors

- G: Shower Door
- H: Storage Door
- J: Double Storage Doors

## EXTERNAL

- K: Single External Door
- L: Double External Doors
- M: Main External Door

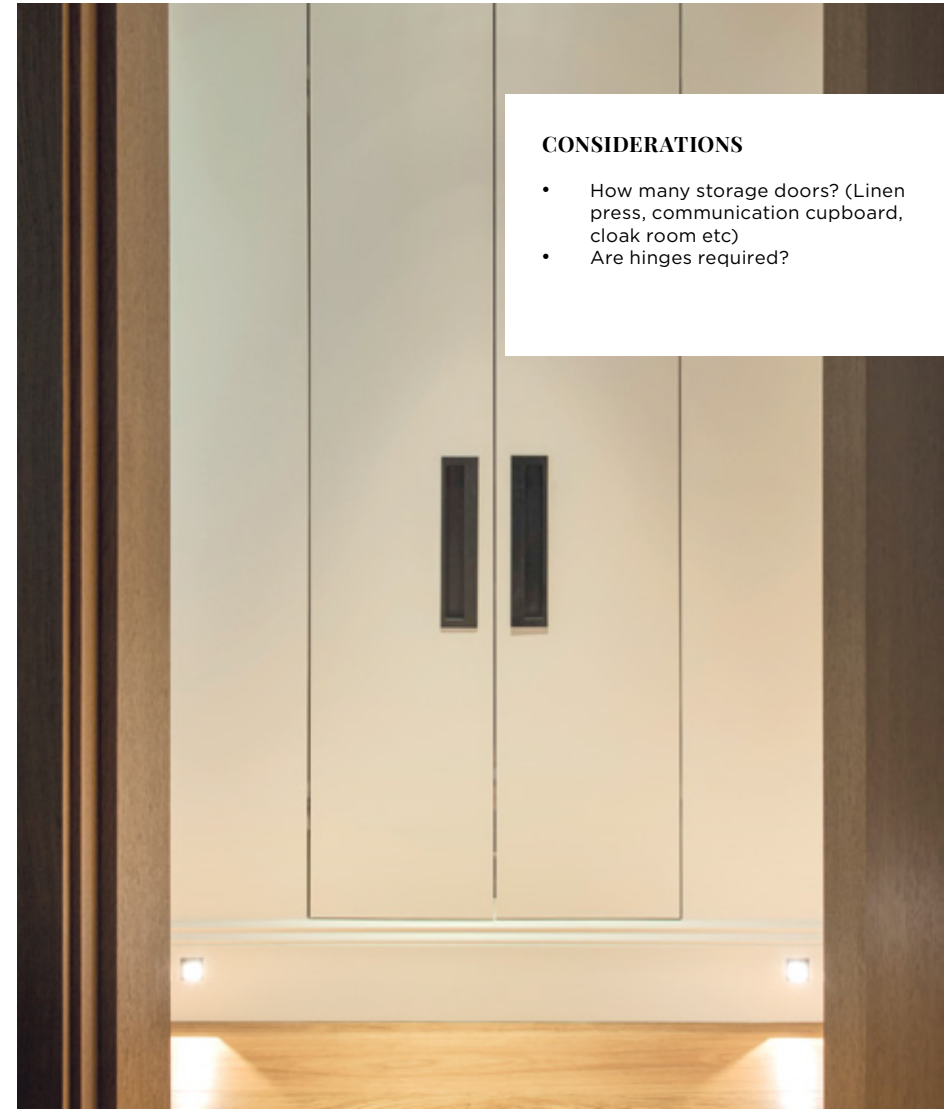

## CONSIDERATIONS

- How many storage doors? (Linen press, communication cupboard, cloak room etc)
- Are hinges required?

## SPECIFY THE FOLLOWING ITEMS:

DOOR KNOB



or DOOR PULL



or EDGE PULL



or FLUSH PULL WITH GRIP

+ INTERNAL ROLLER CATCH OR MAGNETIC CATCH (see overleaf)

# STORAGE DOOR - ROLLER CATCH



## Roller bolt catch LA1026

- A true testament to British engineering, all the components are made from the finest grade of steel and brass, and each catch is carefully hand-assembled to ensure the inner workings dovetail together perfectly and provide a superior operating experience.

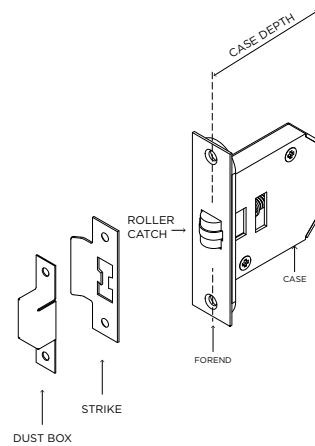

### SPECIFY THE FOLLOWING ITEMS:

LA1026



+ HINGES



+ DOOR STOP



# STORAGE DOOR - MAGNETIC CATCH

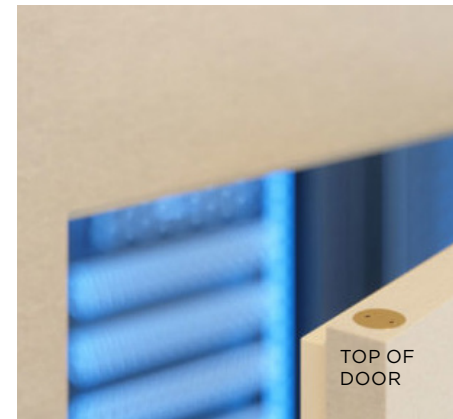
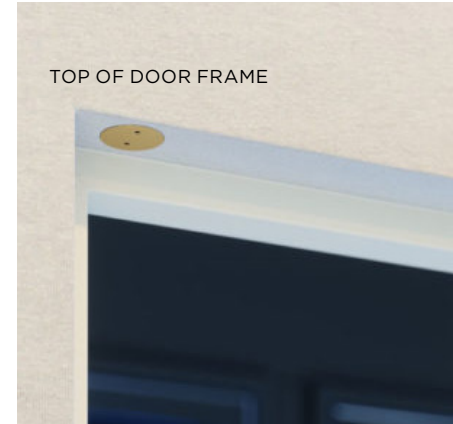

## Magnetic Catch LA1082.01

- Made from solid brass with fully-concealed high-strength neodymium magnets
- Recessed
- Silent operation
- 26mm dia. 16mm depth per piece
- This can be fitted on the top, bottom or leading edge of the door.
- Comes as polarised pair for either top or bottom of full-size doors. Specify two pairs if you wish to have catches at both top and bottom of each door.
- Both parts attach using 6mm woodscrews which are fully concealed once assembled.
- The two dots are for using circlip pliers to control the item into the hole.
- Available in all signature finishes.
- While this is designed for full-size doors, to ensure easy operation the holding force is not as strong as traditional roller catch and so we do not recommend it is used in areas where there is airflow.

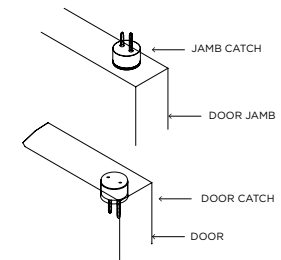

### SPECIFY THE FOLLOWING ITEMS:

LA1082



+ HINGES



+ DOOR STOP





# SPECIFYING SLIDING DOORS - PASSAGE

Sliding doors are hung on a track that moves sideways, usually retracting into a wall cavity. They can be single or double doors.

A flush pull is used to pull the door across. It is 'flush' with the door allowing it to pass into the cavity.

If the door retracts into the wall completely, a person can use a door-end pull positioned on the edge of the door in order to retrieve the door.

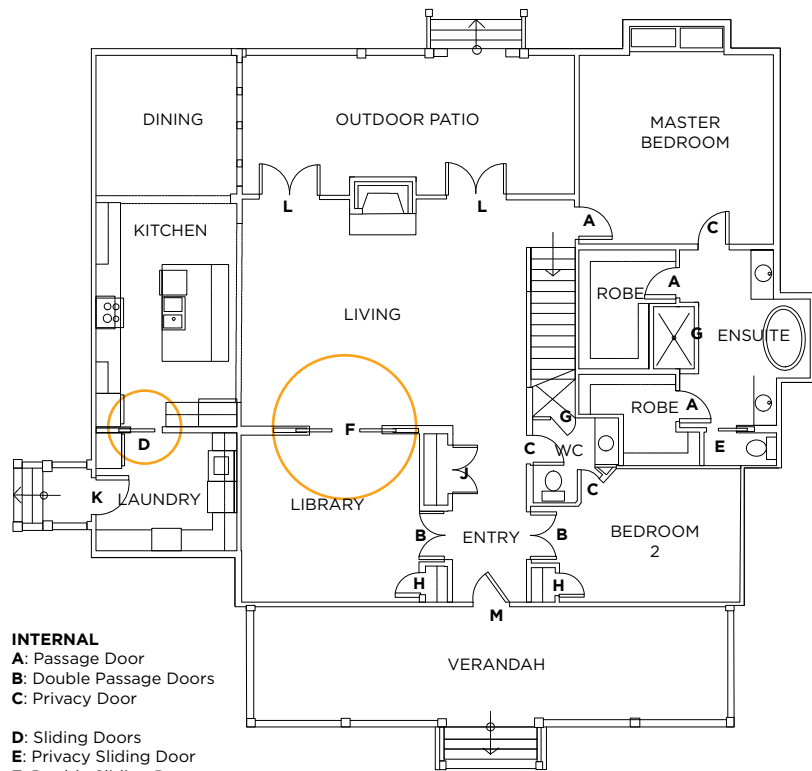

## INTERNAL

- A: Passage Door
- B: Double Passage Doors
- C: Privacy Door

- D: Sliding Doors
- E: Privacy Sliding Door
- F: Double Sliding Doors

- G: Shower Door
- H: Storage Door
- J: Double Storage Doors

## EXTERNAL

- K: Single External Door
- L: Double External Doors
- M: Main External Door

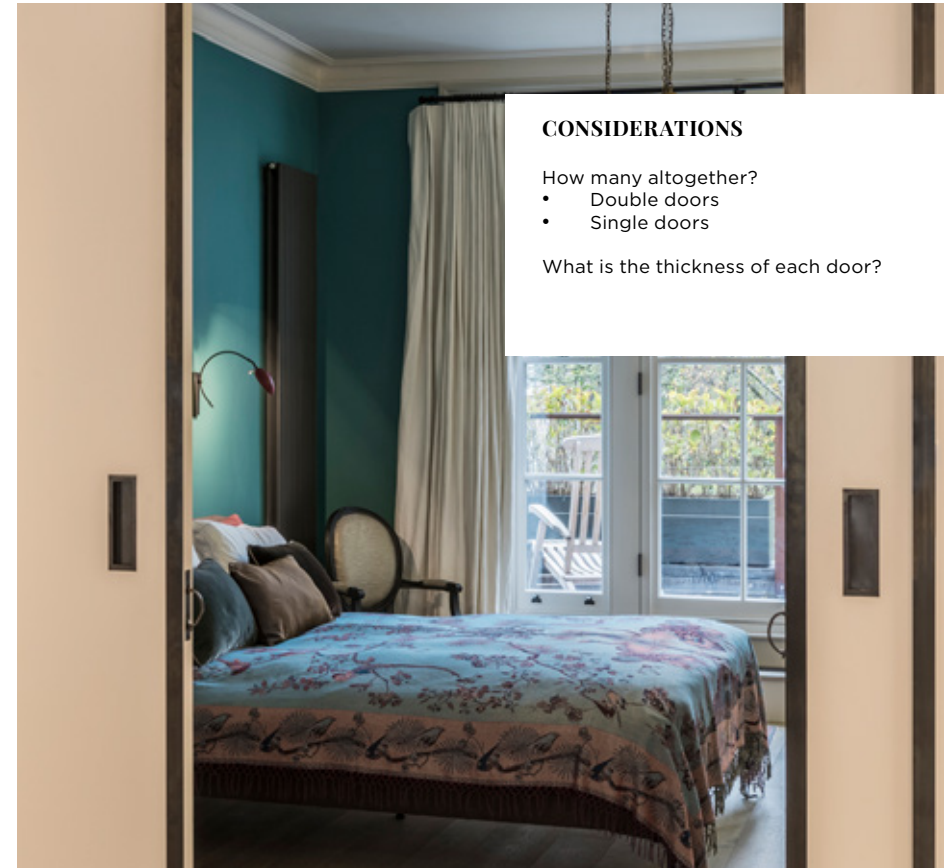

## CONSIDERATIONS

How many altogether?

- Double doors
- Single doors

What is the thickness of each door?

## SPECIFY FROM THE FOLLOWING FLUSH PULL SHAPES:

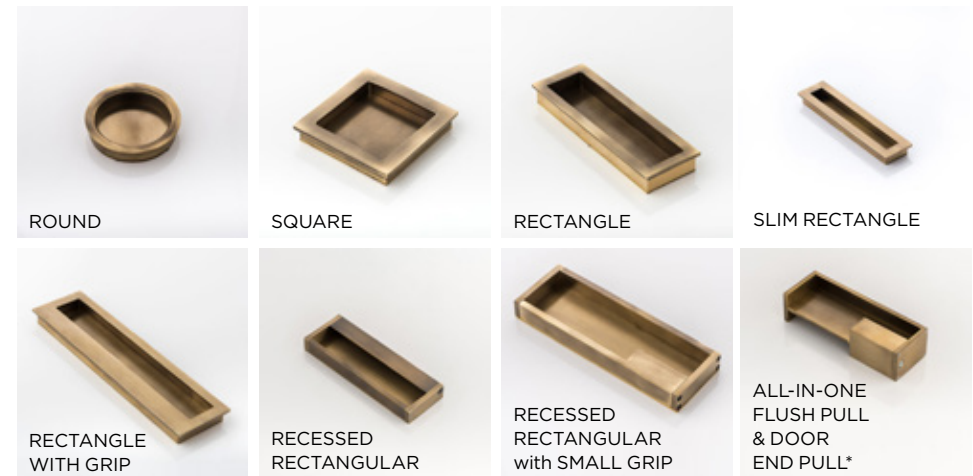

\*Not recommended as requires a non-standard 44mm thick door.

## SLIDING DOORS - DOOR END PULL



**Door End Pull SF1086**  
 This innovative sliding door end pull provides a clever and original way of pulling out a sliding door from its pocket. Once the small brass button is pressed, the little brass handle pops out, thus providing a grip with which to pull the door.

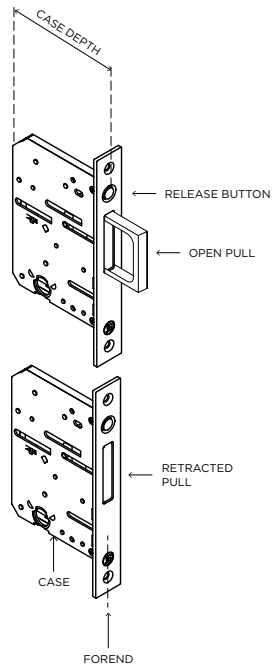

**SPECIFY THE FOLLOWING ITEMS:**

SF1086



## SLIDING DOORS - FINGER PULL



**Finger Pull SF1084**  
 This minimal end pull is installed into the leading edge of a pocket sliding door to enable the door to be pulled out of the pocket. It is simple, functional, and has been designed to be easily operated with one finger.

There are two different depths available, the deeper version is ideal for users with long fingernails. They are available in all our signature finishes and are sold as single items.

Please be advised that these products need to be bonded to the door. This product has passed an installation strength test when fitted with Evo-stick mirror adhesive, however, we have not tested this product and adhesive on every possible door substrate and situation, and so we would recommend undertaking your own tests prior to installation, including Evo-stick mirror adhesive.

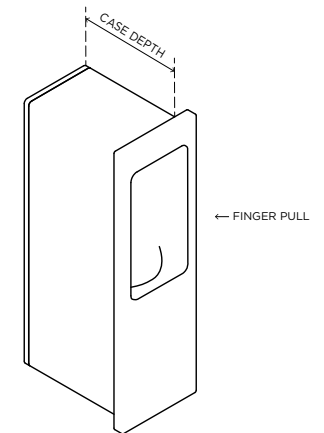

**SPECIFY THE FOLLOWING ITEMS:**

SF1084



# SPECIFYING SLIDING DOORS - PRIVACY

Sliding doors are hung on a track that moves sideways, usually retracting into a wall cavity. They can be single or double doors. A flush pull is used to pull the door across. It is 'flush' with the door allowing it to pass into the cavity. If the door retracts into the wall completely, a person can use a door-end pull positioned on the edge of the door in order to retrieve the door.

This door has an added function of a privacy thumb turn to lock the door whilst in the room. If there is an emergency and no response comes from within, a coin can be used to open the door from the outside by a good samaritan.

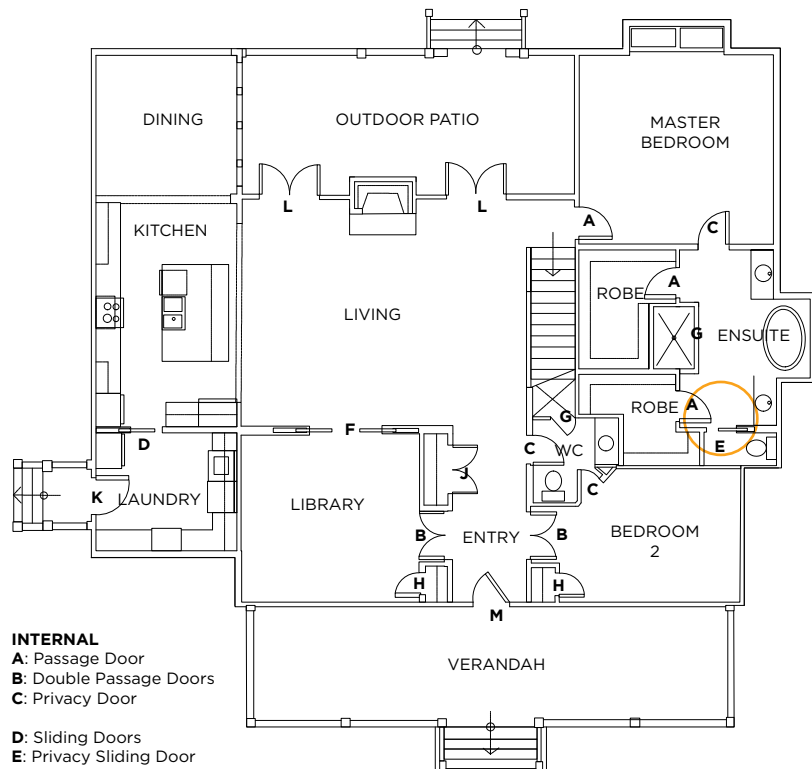

## INTERNAL

- A: Passage Door
- B: Double Passage Doors
- C: Privacy Door

- D: Sliding Doors
- E: Privacy Sliding Door
- F: Double Sliding Doors

- G: Shower Door
- H: Storage Door
- J: Double Storage Doors

## EXTERNAL

- K: Single External Door
- L: Double External Doors
- M: Main External Door

## CONSIDERATIONS

How many are full cavity and go all the way into the case?

How many are partial cavity and only retract part way into the case?

What is the thickness of each door?



SPECIFY ONE OF THE FOLLOWING SHAPES:

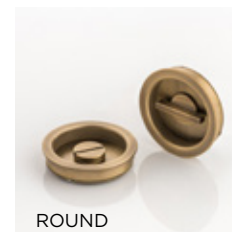

# PRIVACY SLIDING DOORS

## - LOCK



**Sliding Door Lock LA1165**  
 This innovative 'YELLOW' sliding door lock is recessed into the door and the deadbolt is operated by a privacy snib from the inside and emergency release from the outside. Once the snib turn is operated, the deadbolt extends and two metal plates protrude (north and south) from the deadbolt, locking into the strike plate.

These locks are usually installed on doors that lead into a cloakroom, bathroom or WC. The privacy snib and emergency release will need to be compatible with a 8mm square spindle. provides a clever and original way of pulling out a sliding door from its pocket. Once the small brass button is pressed, the little brass handle pops out, thus providing a grip with which to pull the door.

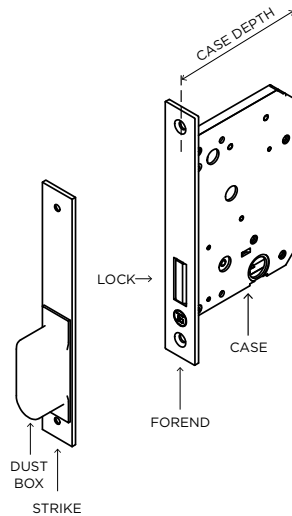

**SPECIFY THE FOLLOWING ITEMS:**

LA1165



# PRIVACY SLIDING DOORS

## - LOCK + DOOR END PULL



**Sliding Door Lock with Pull LA1163**  
 This innovative 'YELLOW' sliding door lock is recessed into the door and the deadbolt is operated by a privacy snib from the inside and emergency release from the outside. Once the snib turn is operated, the deadbolt extends and two metal plates protrude (north and south) from the deadbolt, locking into the strike plate.

The LA1163 also incorporates a handle that enables the door to be pulled out of the pocket, when the button is pressed the handle pops out.

These locks are usually installed on doors that lead into a cloakroom, bathroom or WC. The privacy snib and emergency release will need to be compatible with a 5mm square spindle.

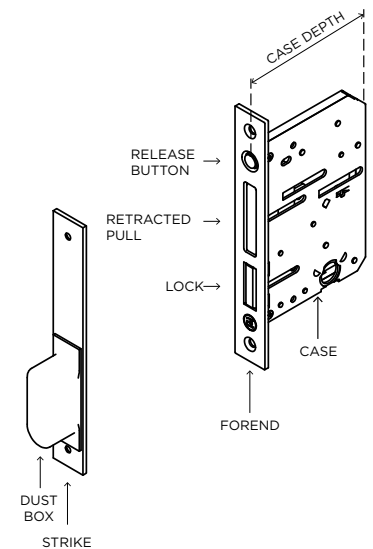

**SPECIFY THE FOLLOWING ITEMS:**

LA1163



# SPECIFYING CABINET HARDWARE:

Cabinet Hardware is non-operating hardware designed to open and close drawers and cupboards, and is found on wardrobes, kitchen and bathroom joinery, in libraries and entertainment units.

They are usually a smaller scale than the matching Door Hardware. Cabinetry door thickness is usually 16-19mm.

One of the benefits of cabinet hardware on joinery, aside from aesthetics, is that handles are very durable and mucky hands won't leave marks on the paintwork.

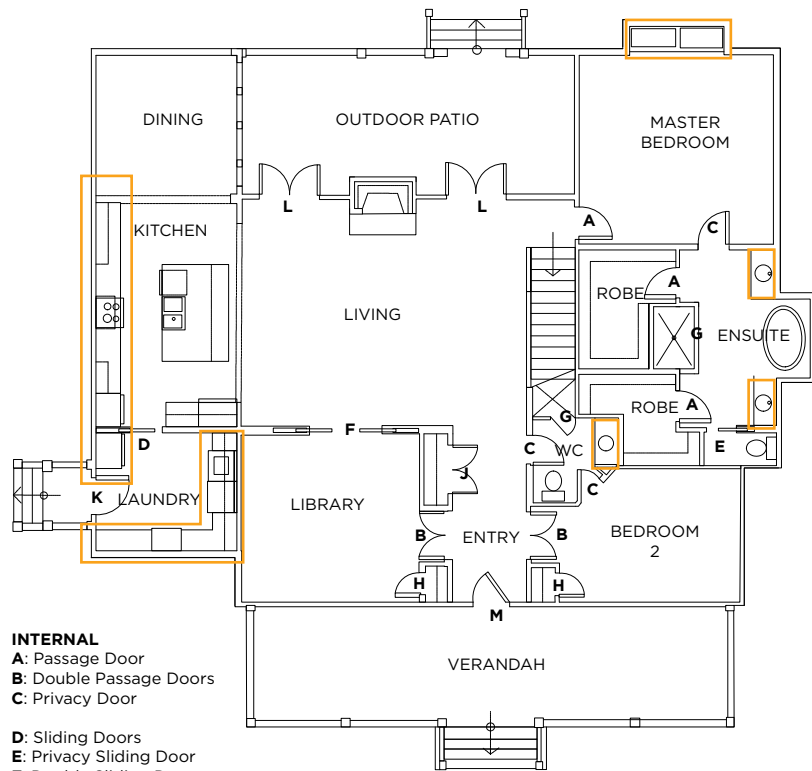

**INTERNAL**

- A: Passage Door
- B: Double Passage Doors
- C: Privacy Door

- D: Sliding Doors
- E: Privacy Sliding Door
- F: Double Sliding Doors

- G: Shower Door
- H: Storage Door
- J: Double Storage Doors

**EXTERNAL**

- K: Single External Door
- L: Double External Doors
- M: Main External Door

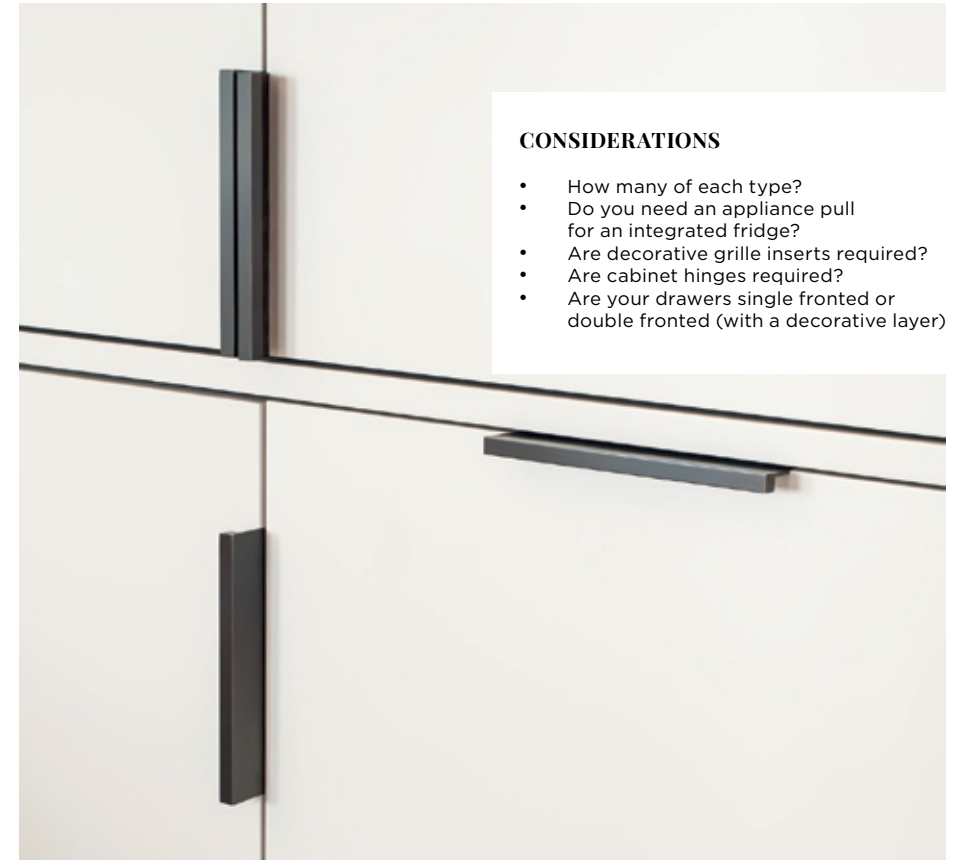

**CONSIDERATIONS**

- How many of each type?
- Do you need an appliance pull for an integrated fridge?
- Are decorative grille inserts required?
- Are cabinet hinges required?
- Are your drawers single fronted or double fronted (with a decorative layer)?

**SPECIFY FROM THE FOLLOWING CABINET HARDWARE OPTIONS:**

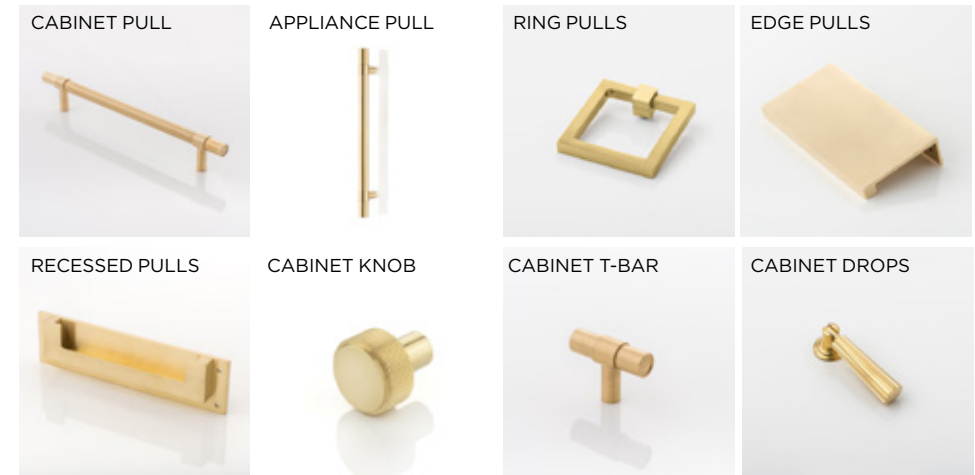



# SPECIFYING DECORATIVE GRILLES:

Decorative Grilles are sheets of hand-woven, hand-assembled or perforated brass or stainless steel that can be used to add detailing to a cupboard door. These are made to size and available in many styles and finishes, with or without backing mesh.

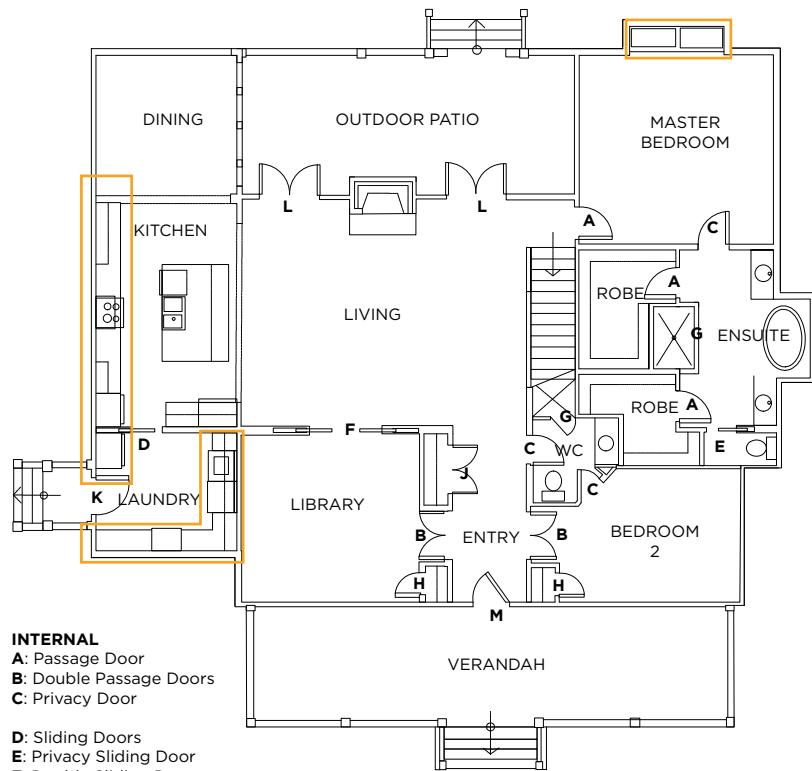

**INTERNAL**

- A: Passage Door
- B: Double Passage Doors
- C: Privacy Door
- D: Sliding Doors
- E: Privacy Sliding Door
- F: Double Sliding Doors
- G: Shower Door
- H: Storage Door
- J: Double Storage Doors

**EXTERNAL**

- K: Single External Door
- L: Double External Doors
- M: Main External Door

**CONSIDERATIONS**

- We quote per square metre initially and once joiner has confirmed exact panel size to nearest mm we re-quote so you only pay for what you require.



**SPECIFY FROM THE FOLLOWING GRILLE OPTIONS:**

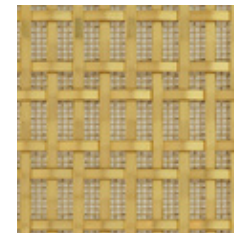

HANDWOVEN VERTICAL OR HORIZONTAL

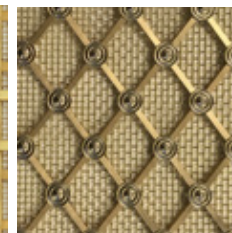

HAND ASSEMBLED DIAMOND 25MM PLAIN ROSETTES

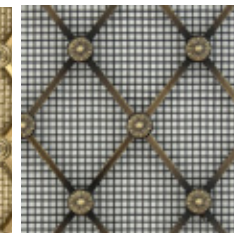

HAND ASSEMBLED DIAMOND 4MM FLORAL ROSETTES

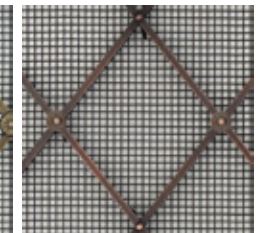

HANDWOVEN DIAMOND 55MM PINS ONLY

# SPECIFYING SHOWER DOOR:

We can provide knobs or rails to open and close your shower doors. Made of solid brass the shower door pull handles are supplied with fixings that will suit 10-12mm thick glass and nylon washers to ensure that the glass is not damaged.

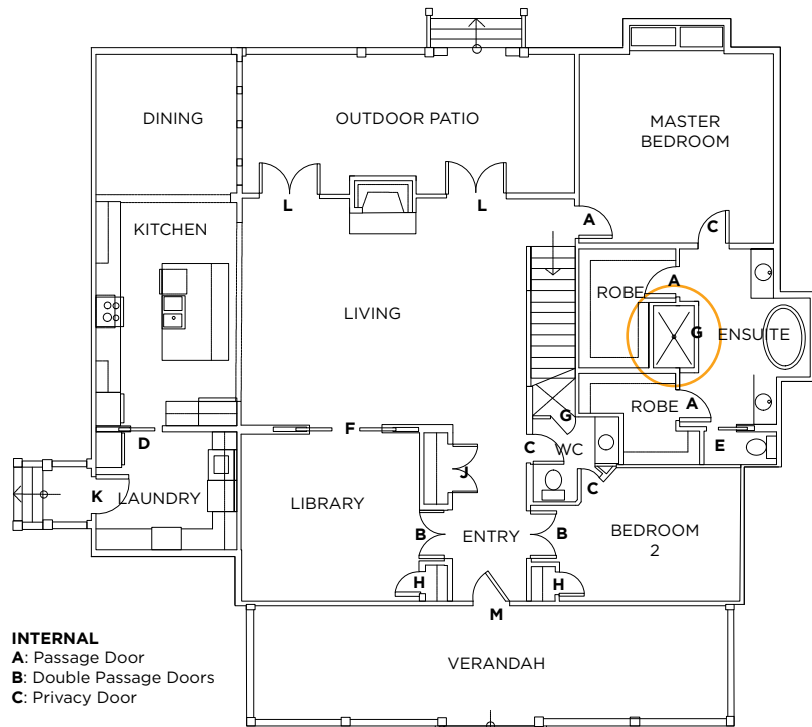

**INTERNAL**

- A: Passage Door
- B: Double Passage Doors
- C: Privacy Door

- D: Sliding Doors
- E: Privacy Sliding Door
- F: Double Sliding Doors

- G: Shower Door
- H: Storage Door
- J: Double Storage Doors

**EXTERNAL**

- K: Single External Door
- L: Double External Doors
- M: Main External Door



**CONSIDERATIONS**

- How many shower doors?
- Do you want knobs or rails?
- Do you want to match your shower door hinges?

**SPECIFY FROM THE FOLLOWING SHOWER HARDWARE OPTIONS:**



WALL MOUNTED SHOWER HINGES



GLASS MOUNTED SHOWER HINGES



BACK TO BACK SHOWER KNOB



BACK TO BACK TOWEL RAIL & SHOWER KNOB



# SPECIFYING WINDOW HARDWARE:

## CASEMENT WINDOWS

Casement windows are hinged windows that open to the left or right.

They will not stay open on their own so require a casement stay to keep open and prevent slamming in the wind. They should be kept shut with a casement fastener.

Some casement fasteners are lockable if required.

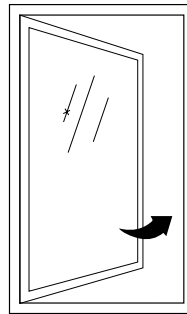

## SASH WINDOWS

Single-hung sash windows are two windows in one frame. The top window is fixed, and using two sash lifts, the bottom window can be lifted with two fingers to open it upwards.

Double-hung sash windows are two unfixed windows in one frame that are counter-balanced and BOTH move when the lower is lifted, with the upper coming down at same time.

To lock the windows, a sash fastener connects the two windows together when closed to prevent entry.

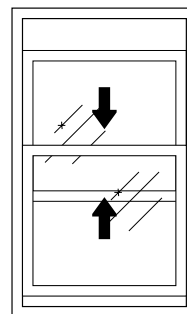
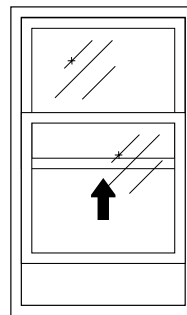

- CONSIDERATIONS**
- How many of each type?
  - Which way do your casement windows open - left or right handed?
  - Do your casement windows need hinges?
  - Do your sash windows need pulleys?
  - Which windows do you require to lock?

## SPECIFY FROM THE FOLLOWING CABINET HARDWARE OPTIONS:

CASEMENT STAY



CASEMENT FASTENER



CASEMENT STAY



CASEMENT FASTENER



SASH PULL



SASH FASTENER



SASH LOCK



SASH PULLEY



# SPECIFYING DOOR STOPS:

The humble door stop is a mighty thing. Without one your beautiful door lever, door knob or hook on the back of your door will damage the wall.

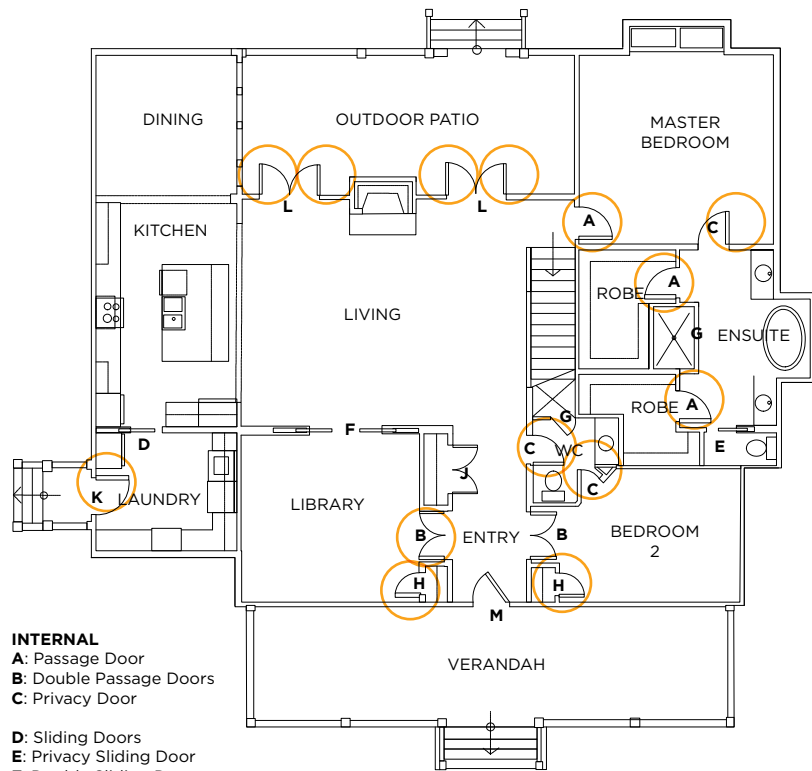

## INTERNAL

- A: Passage Door
- B: Double Passage Doors
- C: Privacy Door

- D: Sliding Doors
- E: Privacy Sliding Door
- F: Double Sliding Doors

- G: Shower Door
- H: Storage Door
- J: Double Storage Doors

## EXTERNAL

- K: Single External Door
- L: Double External Doors
- M: Main External Door

## CONSIDERATIONS

- We will ask you to choose both a wall mounted and a floor mounted design for your project.
- The appropriate door stop will be specified based on what is required per door.
- A general rule is that a 75mm wall mounted door stop will clear the projection of any knob or lever.



## SPECIFY FROM THE FOLLOWING DOOR STOP OPTIONS:

WALL MOUNTED BUMPER

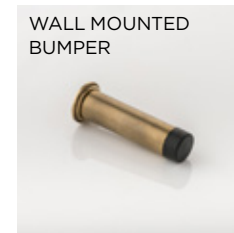

WALL MOUNTED MAGNETIC HOLDER



FLOOR MOUNTED BUMPER



FLOOR MOUNTED DOME WITH BUMPER

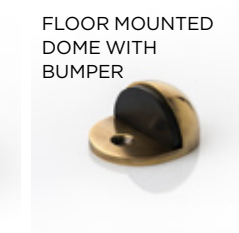

# BASIC GLOSSARY OF HARDWARE TERMS

## **Backset**

The horizontal distance from the face of the lock to the centre line of the cylinder, key hole or knob hub.

## **Barrel**

A cylindrical portion of the cylinder that rotates when the correct key is used.

## **Cylinder**

The assembly incorporating the key operated mechanism.

## **Deadbolt**

A bolt which is not activated by a spring. When locked the bolt cannot be returned by end pressure.

## **Deadlock**

A lock incorporating a key on both sides of the door.

## **Deadlocking Latch**

A lock with a spring-actuated latch bolt. When the door is closed, the key or turn knob is operated to deadlock the latch bolt against return by end pressure.

## **Finish**

Final cover treatment of the product

for appearance & protection, in both plated finishes or powder coat colour.

## **Furniture**

Fittings complementary to the lock systems, such as handles and escutcheon plates.

## **Grand Master Key**

A key which will operate two or more groups of locks, where each group can be operated by individual master keys and locks within each group can be operated by different service keys.

## **Handed Products**

A product designed or assembled for use only on right hand doors or only left hand doors, but not both.

## **Handing**

The direction of door travel (swinging or sliding) and the locking/secure side of a door, eg. Right hand (opening out), left hand (opening out).

## **Jamb**

Vertical posts or pieces that together form the sides of a door or window frame.

## **Keyed Alike**

Indicates identical key for 2 or more locks.

## **Keyed to Differ**

A different key is needed to activate each lock.

## **Latch**

The fastening on a door that fits into the notch or slot on a door jamb and is lifted from either side by the handle.

## **Latch bolt**

A spring actuated, bevelled bolt usually operated by door furniture.

## **Lockset**

A lock, complete with strike and door furniture, such as knobs, levers, escutcheons, or handles.

## **Master Key**

A key which will operate a group of locks, each built to operate on a different service key.

## **Mortice**

An opening made to receive a lock or other hardware. Also the act of making such an opening.

## **Mortice Lock**

A lock designed to be recessed into the edge of a door, rather than being mounted to its surface.

## **Non-handed**

The ability to reverse the product or key component to suit left or right-hand installation.

## **Passage Set**

A term commonly used to describe a latch set with handles on both sides of a door but no locking function.

## **Pitch**

Distance from centre of spindle to centre of Euro cutout or Privacy turn or Coin release

## **Privacy Set**

A term for locks used on bathroom and bedroom doors having an inside button or turn knob to lock the outside handle and usually an emergency function which will unlock the set from the outside.

## **Rebated Door**

A door where the leading edge is stepped.

## **Rebated lock/latch**

A lock which has the faceplate and strike shaped to match the rebated edge of a door, usually the meeting edges of two door leaves.

## **Rim Lock, Rim Latch**

A lock or latch which is mounted to the surface of a door, rather than inserted into the edge of the door.

## **Snib**

A device used to either lock or unlock the lockset. Also known as Thumb-turn.

## **Spindle**

The drive shaft that connects the knob or lever to the latch or lock mechanism to operate the bolt.

## **Strike**

A device fixed in or on a doorjamb into which the lock or latch bolt engages when the door is closed.

## **Surface Mounted**

The lock is mounted on the surface of the door stile.

## **Thumb-Turn**

A device used to either lock or unlock the lockset. Also known as Snib.

## **Tubular Bolt/latch**

A bolt having a tubular case.

## **Turn Knob**

Turning mechanism that activates the door lock from the inside, a convenient locking option in place of a key.

— THE —  
ENGLISH  
TAPWARE  
— COMPANY —

**MELBOURNE SHOWROOM**  
751 HIGH ST, ARMADALE, VIC 3143  
**Phone:** 03 9818 1403

**SYDNEY SHOWROOM**  
170 QUEEN ST, WOOLLAHRA, NSW 2025  
**Phone:** 02 9362 4736

**Website:** [www.englishtapware.com.au](http://www.englishtapware.com.au)  
**Instagram:** @theenglishtapwarecompany