

JOSEPH GILES



A Guide to Latches, Locks & Hinges

THE ENGLISH TAPWARE COMPANY

170 QUEEN ST, WOOLLAHRA, SYDNEY 2025 • 751 HIGH ST, ARMADALE, MELBOURNE 3143 • www.englishtapware.com.au

A Guide to Latches, Locks & Hinges

Questions To Ask When Selecting Door Locks:

How thick is your door? The first question to ask when selecting door hardware is “How thick is your door?” New interior doors are available as 35 or 40mm thick while existing doors can be up to 60mm thick. Once you know your door thickness, you can select the appropriate lock and hardware combination to fit on that door.

How wide is the stile? The stile is the vertical edge board on a panelled door. It looks best to have the handle and privacy in the centre of the stile so a 90mm wide stile needs a 45mm handle backset. For a flat or flush door it is usual to have a 60mm backset from the edge of the door to the handle. Select the latch with a backset depth to suit your door.

Are you using a door knob or lever? If you are fitting a knob to a door, the latch within the door requires light springing to return the knob to its original position once rotated. A lever handle however needs to be supported in a horizontal position for a long time to come and the heavier the handle, the stronger the spring mechanism required to fully support it into the future. Select the combination of lock strength and supporting rosette springing mechanism to suit the weight of the lever handle.

Index

JOSEPH GILES ROTA BEARINGS	2-3
TUBULAR LATCHES AND LOCKS	4-5
MORTICE LATCHES AND LOCKS	6-10
HORIZONTAL MORTICE LOCKS	11-12
SLIDING DOOR PRIVACY LOCKS	13-14
ROLLER CATCHES	15
DOOR BOLT	16-19
HINGES	20-22
EURO CYLINDERS	23

FT1045 - FITTING JIG FOR THE ROTA ROSES

The JOSEPH GILES fitting jig for the ROTA roses contains:

- Two drill bits to drill the required holes into the door
- A solid aluminium drill guide
- A mechanism for centring the Jig around the latch follower

JOSEPH GILES TECHNICAL HELP SHEETS

Download the ROTA Technical Help Sheets from our website.

Joseph Giles Door Handle Rota Rose

JOSEPH GILES has designed a mechanism to fit within the rose of its knobs and lever handles to provide additional support to the latch. This unique ROTA bearing is screw-fixed onto the door behind the handle rosette and usually as a pair either side of the door. It supports the handle spindle in a central position and is made in four versions.

The JOSEPH GILES ROTA bearing is available as a basic rose, a fixed rose, an unsprung rose and a sprung rose (with either left-hand or right-hand rotation).

- **Basic** rose is for privacy turns and escutcheons
- **Fixed** rose is for fixed wardrobe and cupboard doors. It is a type of Taylor or dummy spindle.
- **Unsprung** rose is for door knobs or for lever handles used with a heavy sprung latch that does not need additional support
- **Sprung** rose provides support for lever handles used with an existing latch or with a new medium sprung latch

The unsprung rose is recessed 8mm into each side of the door. Allowing 18mm for the latch the **minimum door thickness is 35mm.**

The sprung rose is recessed 10.5mm into each side of the door. Allowing 18mm for the latch the **minimum door thickness is 40mm.**

If your existing door thickness is less than 40mm you can order JOSEPH GILES lever handles with unsprung roses and purchase JOSEPH GILES' heavy sprung latches with an internal spring strong enough to support the weight of the lever.

Joseph Giles Door Handle Rota Rose

Basic Rose

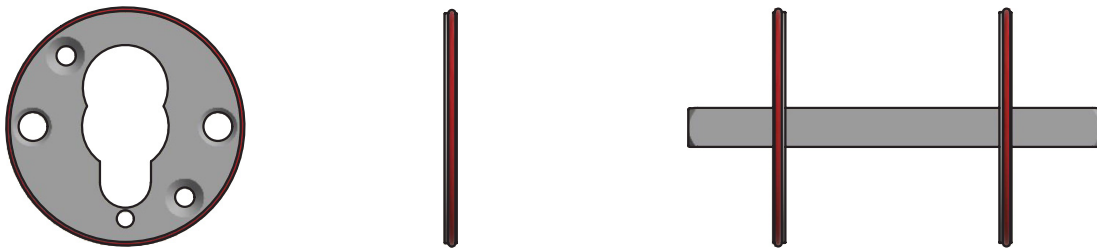

Fixed Rose

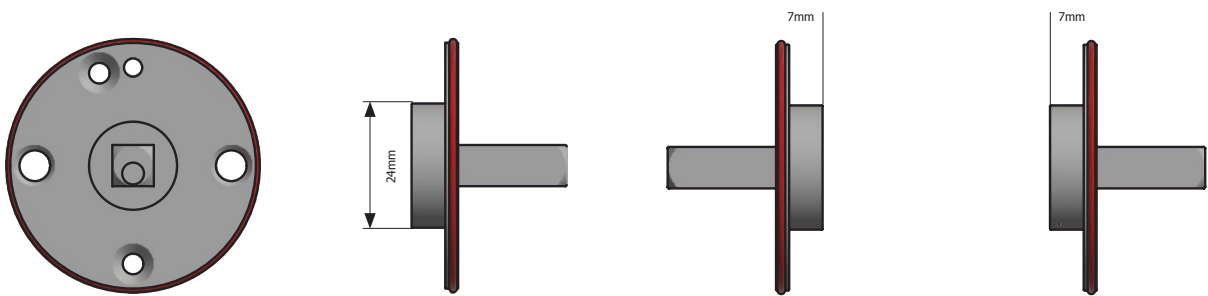

Unsprung Bearing Rose

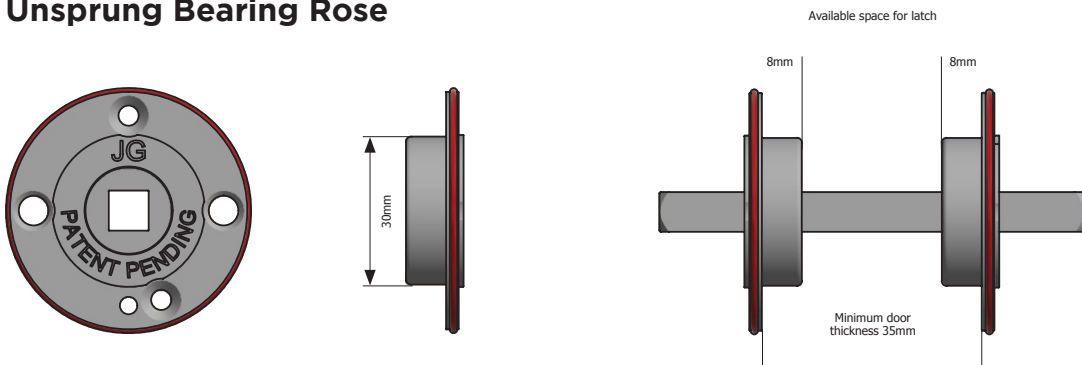

Sprung Bearing Rose

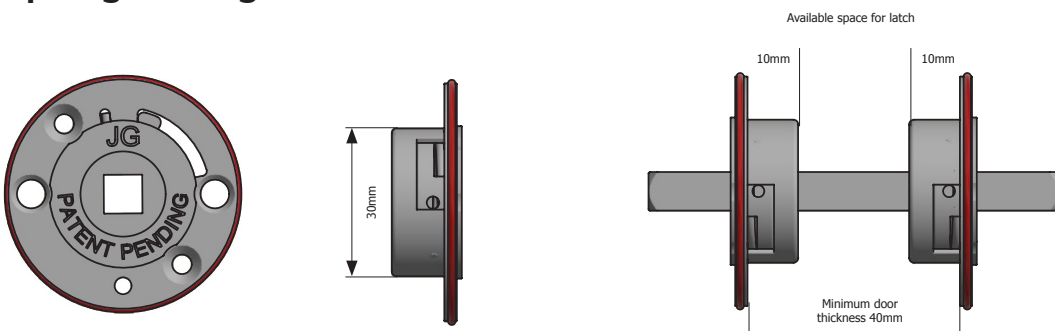

Internal Door – Tubular Latch

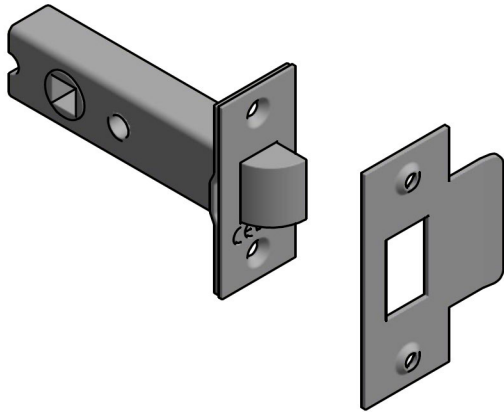

INTERNAL DOOR WITH 45mm BACKSET

LA1161.01 – Tubular latch for internal door. **45mm backset** for handle. Case 70mm deep. Forend 25 x 57mm and strike 29 x 70mm. Supplied with metal dustbox.

INTERNAL DOOR WITH 60mm BACKSET

LA1161.02 – Tubular latch for internal door. **60mm backset** for handle. Case 80mm deep. Forend 25 x 57mm and strike 29 x 70mm. Supplied with metal dustbox.

INTERNAL DOOR WITH 75mm BACKSET

LA1161.03 – Tubular latch for internal door. **75mm backset** for handle. Case 100mm deep. Forend 25 x 57mm and strike 29 x 70mm. Supplied with metal dustbox.

INTERNAL DOOR WITH 100mm BACKSET

LA1161.04 – Tubular latch for internal door. **100mm backset** for handle. Case 127mm deep. Forend 25 x 57mm and strike 29 x 70mm. Supplied with metal dustbox.

INTERNAL DOOR WITH 130mm BACKSET

LA1161.05 – Tubular latch for internal door. **130mm backset** for handle. Case 151mm deep. Forend 25 x 57mm and strike 29 x 70mm. Supplied with metal dustbox.

This tubular latch is recessed into the edge of the door and the latch-bolt is operated by a pair of knobs or lever handles. This latch is used for non-locking doors and may be paired with the LA1017 tubular bolt to create a bathroom door privacy set.

These latches are available in three spring strengths:

- LA1161 (L)** – LIGHT SPRUNG for door knobs
- LA1161 (M)** – MEDIUM SPRUNG for lever handles
- LA1161 (H)** – HEAVY SPRUNG for rose-less levers

Use these LA1161 tubular latches with JOSEPH GILES door knobs (DK series) and lever handles (LV series).

Available finishes are PBW, BBW, MABW, DBZW, PSS and SSS.

Internal Door – Tubular Privacy Lock



This tubular privacy lock is recessed into the edge of the door and the privacy-bolt is operated by a privacy thumb-turn from the inside and an emergency release on the outside. This lock may be paired with the LA1161 tubular latch to create a bathroom door privacy set.

Use these LA1017 tubular privacy locks with the JOSEPH GILES thumb turns (TT1 series) and coin releases (RL1 series).

Available finishes are PBW, BBW, MABW, DBZW, PSS and SSS.

PRIVACY LOCK FOR INTERNAL DOOR WITH 60mm BACKSET

LA1017.01 – Tubular privacy lock for internal door. **60mm backset** for handle. Case 83mm deep. Forend 25 x 57mm and strike 27 x 70mm. Supplied with metal dustbox.

PRIVACY LOCK FOR INTERNAL DOOR WITH 75mm BACKSET

LA1017.02 – Tubular privacy lock for internal door. **75mm backset** for handle. Case 100mm deep. Forend 25 x 57mm and strike 27 x 70mm. Supplied with metal dustbox.

PRIVACY LOCK FOR INTERNAL DOOR WITH 100mm BACKSET

LA1017.03 – Tubular privacy lock for internal door. **100mm backset** for handle. Case 127mm deep. Forend 25 x 57mm and strike 27 x 70mm. Supplied with metal dustbox.

PRIVACY LOCK FOR INTERNAL DOOR WITH 130mm BACKSET

LA1017.04 – Tubular privacy lock for internal door. **130mm backset** for handle. Case 151mm deep. Forend 25 x 57mm and strike 27 x 70mm. Supplied with metal dustbox.

Internal Door – Mortice Latch



INTERNAL DOOR WITH 60mm BACKSET

LA1155.01 – Mortice latch for internal door. **60mm backset** for handle. Case size 165h x 90d x 15mm. Forend 24 x 235mm and strike 26 x 99mm. Supplied with metal dustbox.

INTERNAL DOOR WITH 80mm BACKSET

LA1155.02 – Mortice latch for internal door. **80mm backset** for handle. Case size 165h x 110d x 15mm. Forend 24 x 235mm and strike 26 x 99mm. Supplied with metal dustbox.

RIGHT-HAND REBATE KIT

LA1160RH – Right-hand rebate kit for LA1155 and LA1157 mortice latches installed into a pair of internal doors with rebated meeting styes.

LEFT-HAND REBATE KIT

LA1160LH – Left-hand rebate kit for LA1155 and LA1157 mortice latches installed into a pair of internal doors with rebated meeting styes.

EXTENDED STRIKE PLATE

XS1155.02 – Extended strike plate for an extra-wide door frame for LA1155/LA1157 mortice latches. (6mm longer lead-in lip.)

The Joseph Giles “Orange” latches and locks are the absolute essence of top-quality British engineering with every component engineered from the highest quality brass and steel. They are carefully hand-assembled to ensure the inner workings dovetail perfectly together to provide seamless operation and a latch that will last a lifetime.

This mortice latch is recessed into the edge of the door and the latch-bolt is operated by pair of knobs or lever handles. These latches are used on non-locking doors.

These latches are available in three spring strengths:

- LA1155 (L)** – LIGHT SPRUNG for door knobs
- LA1155 (M)** – MEDIUM SPRUNG for lever handles
- LA1155 (H)** – HEAVY SPRUNG for rose-less levers

Use these LA1155 mortice latches with JOSEPH GILES door knobs (DK series) and lever handles (LV series).

Available in the standard JOSEPH GILES metal finishes: PBW, BBW, PN, BN, CP, MABW, DBZW.

Internal Door – Mortice Latch With Privacy Lock

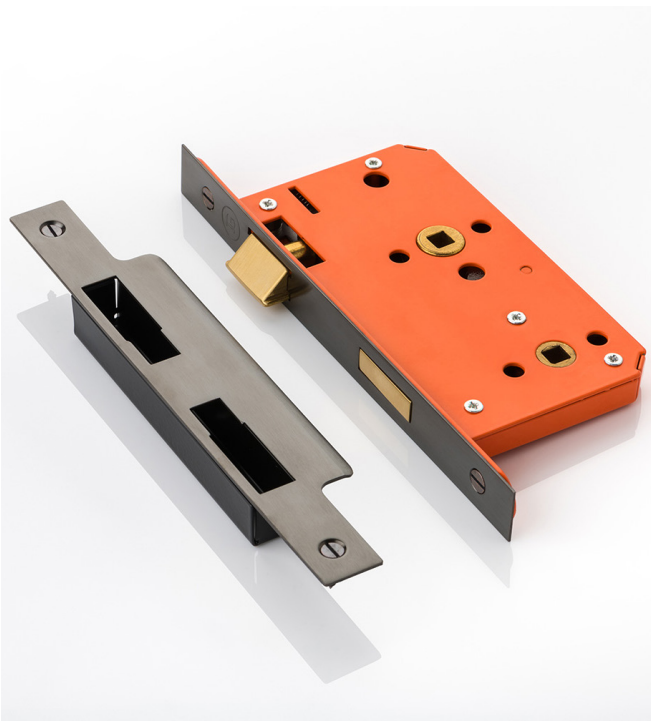

The Joseph Giles “Orange” latches and locks are the absolute essence of top-quality British engineering with every component engineered from the highest quality brass and steel. They are carefully hand-assembled to ensure the inner workings dovetail perfectly together to provide seamless operation and a latch that will last a lifetime.

This mortice latch with privacy is recessed into the edge of the door. The latch-bolt is operated by pair of knobs or lever handles and the privacy-bolt is operated by a privacy thumb-turn from the inside and an emergency release on the outside.

These latches are available in three spring strengths:

- LA1156 (L)** – LIGHT SPRUNG for door knobs
- LA1156 (M)** – MEDIUM SPRUNG for lever handles
- LA1156 (H)** – HEAVY SPRUNG for rose-less levers

Use these LA1156 latches with JOSEPH GILES door knobs (DK series) and lever handles (LV series) and for the privacy use JOSEPH GILES thumb turns (TT1 series) and coin releases (RL1 series).

Available in the standard JOSEPH GILES metal finishes: PBW, BBW, PN, BN, CP, MABW, DBZW.

INTERNAL DOOR WITH 60mm BACKSET

LA1156.01 – Mortice latch with privacy for internal door. **60mm backset** for handle and **78mm centres**. Case size 165h x 90d x 15mm. Forend 24 x 235mm and strike 24 x 235mm. Supplied with metal dustbox.

INTERNAL DOOR WITH 80mm BACKSET

LA1156.02 – Mortice latch with privacy for internal door. **80mm backset** for handle and **78mm centres**. Case size 165h x 110d x 15mm. Forend 24 x 235mm and strike 24 x 235mm. Supplied with metal dustbox.

RIGHT-HAND REBATE KIT

LA1159RH – Right-hand rebate kit for LA1154 and LA1156 mortice latches installed into a pair of internal doors with rebated meeting styes.

LEFT-HAND REBATE KIT

LA1159LH – Left-hand rebate kit for LA1154 and LA1156 mortice latches installed into a pair of internal doors with rebated meeting styes.

EXTENDED STRIKE PLATE

XS1154.02 – Extended strike plate for an extra-wide door frame for LA1154 and LA1156 mortice latches. (5mm longer lead-in lip.)

Entrance Door – Mortice Latch/Lock For Euro Cylinder

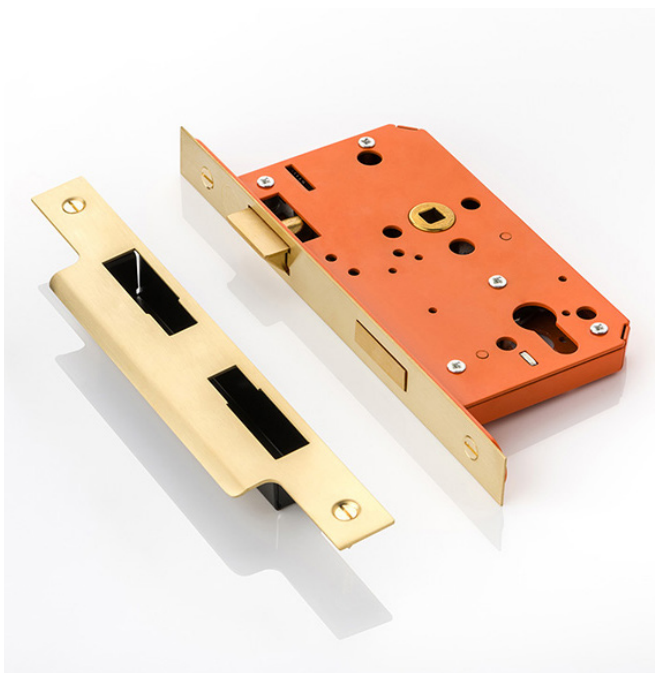

The Joseph Giles “Orange” latches and locks are the absolute essence of top-quality British engineering with every component engineered from the highest quality brass and steel. They are carefully hand-assembled to ensure the inner workings dovetail perfectly together to provide seamless operation and a latch that will last a lifetime.

This mortice latch/lock is recessed into the edge of the door. The latch-bolt is operated by pair of knobs or lever handles. The dead-bolt is operated by a Euro cylinder and may have a key both sides or a key one side and a thumb-turn on the other. The Euro cylinder also opens the latch-bolt so a knob or lever is not required.

Euro cylinders are not supplied with Joseph Giles locks and need to be specified or procured separately.

These latches are available in three spring strengths:

- LA1154 (L)** – LIGHT SPRUNG for door knobs
- LA1154 (M)** – MEDIUM SPRUNG for lever handles
- LA1154 (H)** – HEAVY SPRUNG for rose-less levers

Use these LA1154 latches with JOSEPH GILES door knobs (DK series) and lever handles (LV series).

Available in the standard JOSEPH GILES metal finishes: PBW, BBW, PN, BN, CP, MABW, DBZW.

ENTRANCE DOOR WITH 60mm BACKSET

LA1154.01 – Mortice latch and lock for Euro cylinder. The latchbolt is opened by levers or knob handles. **60mm backset** for handle and **72mm centres**. Case size 165h x 90d x 15mm. Forend 24 x 235mm and strike 26 x 99mm. Supplied with metal dustbox.

ENTRANCE DOOR WITH 80mm BACKSET

LA1154.02 – Mortice latch and lock for Euro cylinder. **80mm backset** for handle and **72mm centres**. Case size 165h x 110d x 15mm. Forend 24 x 235mm and strike 26 x 99mm. Supplied with metal dustbox.

RIGHT-HAND REBATE KIT

LA1159RH – Right-hand rebate kit for LA1154 and LA1156 mortice latches installed into a pair of internal doors with rebated meeting styes.

LEFT-HAND REBATE KIT

LA1159LH – Left-hand rebate kit for LA1154 and LA1156 mortice latches installed into a pair of internal doors with rebated meeting styes.

EXTENDED STRIKE PLATE

XS1154.02 – Extended strike plate for an extra-wide door frame for LA1154 and LA1156 mortice latches. (5mm longer lead-in lip.)

Entrance Door – Night Latch For Euro Cylinder

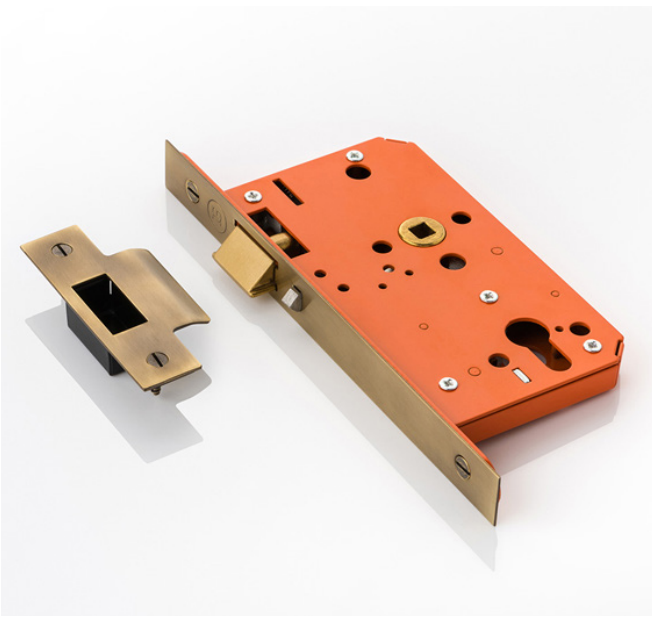

The Joseph Giles “Orange” latches and locks are the absolute essence of top-quality British engineering with every component engineered from the highest quality brass and steel. They are carefully hand-assembled to ensure the inner workings dovetail perfectly together to provide seamless operation and a latch that will last a lifetime.

“Night-latches” are fitted into the front door with no lever or knob needed on the outside. From the outside the latch-bolt is opened by a key in the Euro cylinder and from the inside it can be opened by turning a thumb-turn in the other end of the cylinder. The door can also be opened by a lever handle on the inside of the door instead of the thumb-turn.

Euro cylinders are not supplied with Joseph Giles locks and need to be specified or procured separately.

These latches are available in three spring strengths:

- LA1157 (L)** – LIGHT SPRUNG for door knobs
- LA1157 (M)** – MEDIUM SPRUNG for lever handles
- LA1157 (H)** – HEAVY SPRUNG for rose-less levers

Available in the standard JOSEPH GILES metal finishes: PBW, BBW, PN, BN, CP, MABW, DBZW.

ENTRANCE DOOR WITH 60mm BACKSET

LA1157.01 – Mortice night-latch for Euro cylinder. The latch bolt can be opened by a key in the Euro cylinder from the outside and a lever handle or turn on the inside. **60mm backset** for the handle and **72mm centres**. Case size 165h x 90d x 15mm. Forend 24 x 99mm and strike 26 x 99mm. Supplied with metal dustbox.

ENTRANCE DOOR WITH 80mm BACKSET

LA1157.02 – Mortice night-latch for Euro cylinder. The latch bolt can be opened by a key in the Euro cylinder from outside and a lever handle or turn on the inside. **80mm backset** for the handle and **72mm centres**. Case size 165h x 110d x 15mm. Forend 24 x 99mm and strike 26 x 99mm. Supplied with metal dustbox.

RIGHT-HAND REBATE KIT

LA1160RH – Right-hand rebate kit for LA1155 and LA1157 mortice latches installed into a pair of internal doors with rebated meeting styes.

LEFT-HAND REBATE KIT

LA1160LH – Left-hand rebate kit for LA1155 and LA1157 mortice latches installed into a pair of internal doors with rebated meeting styes.

EXTENDED STRIKE PLATE

XS1155.02 – Extended strike plate for an extra-wide door frame for LA1155 and LA1157 mortice latches. (6mm longer lead-in lip.)

Lock For Euro Cylinder



DEADLOCK WITH 45mm BACKSET

LA1008.01 – Deadlock for Euro cylinder.
45mm backset. Case size 63d x 76h x 15mm.
Forend 26 x 96mm and strike 26 x 134mm.
Supplied with metal dustbox.

DEADLOCK WITH 57mm BACKSET

LA1008.02 – Deadlock for Euro cylinder.
57mm backset. Case size 76d x 76h x 15mm.
Forend 26 x 96mm and strike 26 x 134mm.
Supplied with metal dustbox.

DEADLOCK WITH 82mm BACKSET

LA1008.03 – Deadlock for Euro cylinder.
82mm backset. Case size 101d x 76h x 15mm.
Forend 26 x 96mm and strike 26 x 134mm.
Supplied with metal dustbox.

This deadlock is recessed in to the side of the door. Its dead-bolt is operated by a Euro cylinder with keys both sides or a key on one and a thumb-turn on the other. Euro cylinders are not supplied with Joseph Giles locks and need to be specified or procured separately.

Use this LA1008 mortice lock for an entrance or external door where you require a keyed locking function on one or both sides.

Available in PBW, MABW, DBZW, PSS and SSS finishes

Roller Catches



ROLLER CATCH

LA1026.01 – Roller catch for the side or top of a door. Case size 65d x 62h x 14mm. Forend 25 x 101mm and strike 22 x 58mm. Supplied with metal dustbox.

These roller bolts are used in push-pull applications for single or double doors. They can be installed in the head or the side of a door and they are usually fitted in conjunction with door pull handles.

Available in PBW, MABW, DBZW, PSS, SSS.

Entrance Door – Horizontal Latch For Euro Cylinder



HORIZONTAL LATCH LOCK

LA1039.02 - Horizontal mortice lock with Euro cylinder cutout. **127mm backset for handle and 51mm for Euro cylinder.** Case size 149d x 70h x 15mm. Forend 25 x 101mm and strike 25 x 145mm. Supplied with metal dustbox.

REBATE KIT FOR DOORS 44-54MM

LA1084.01 - Rebate kit for LA1039 mortice latch installed into a pair of internal doors with rebated meeting styes. Door thickness 44-54mm.

REBATE KIT FOR DOORS 54-64MM

LA1084.02 - Rebate kit for LA1039 mortice latch installed into a pair of internal doors with rebated meeting styes. Door thickness 54-64mm.

This horizontal latch lock is recessed into the door. The latch-bolt is operated by a pair of knobs or door levers and the dead-bolt by a key or thumb-turn in a Euro cylinder.

Use this LA1039 mortice lock for an entrance or external door where you require a keyed locking function on the outside and/or inside and couple it with JOSEPH GILES door knobs (DK series). Euro cylinders are not supplied with the locks and need to be specified or procured separately.

Available in PBW, BBW, MABW, DBZW, PSS and SSS.

Internal Door – Horizontal Latch With Privacy Lock



This horizontal privacy latch lock is recessed into the door. The latch-bolt is operated by a pair of door knobs and the deadbolt is operated by a privacy snib from the inside and emergency release from the outside.

Use this LA1041 latch in doors that lead into a powder-room, bathroom or WC coupled with JOSEPH GILES door knobs (DK series) and for the privacy use JOSEPH GILES thumb turns (TT1 series) and coin releases (RL1 series).

The privacy snib and emergency release will need to be compatible with a 5mm square spindle.

Available in PBW, BBW, MABW, DBZW, PSS and SSS.

HORIZONTAL PRIVACY LATCH LOCK

LA1041.01 – Horizontal mortise latch and lock. **102mm backset for handle and 38mm for privacy.** Case size 123d x 70h x 15mm. Forend 25 x 101mm and strike 25 x 145mm. Supplied with metal dustbox

HORIZONTAL PRIVACY LATCH LOCK

LA1041.02 – Horizontal mortise latch lock. **127mm backset for handle and 51mm for privacy.** Case size 149d x 70h x 15mm. Forend 25 x 101mm and strike 25 x 145mm. Supplied with metal dustbox.

REBATE KIT FOR DOORS 44-54MM

LA1084.01 – Rebate kit for LA1041 mortise latch installed into a pair of internal doors with rebated meeting styes. Door thickness 44-54mm

REBATE KIT FOR DOORS 54-64MM

LA1084.02 – Rebate kit for LA1041 mortise latch installed into a pair of internal doors with rebated meeting styes. Door thickness 54-64mm.

Sliding Door – Hook Style Privacy



PRIVACY LOCK FOR SLIDING DOOR

LA1002.01 – Privacy lock for a sliding door. Hook style catch. **57mm backset**. Case size 76d x 108h x 15mm. Forend 26 x 153mm and strike 26 x 102mm.

This sliding door lock is recessed into the door and the dead-bolt is operated by a privacy thumb-turn from the inside and emergency release from the outside.

These locks are usually installed on doors that lead into a powder-room, bathroom or WC. The privacy thumb-turn and emergency release need to be compatible with a 5mm square spindle.

Minimum door thickness when used with JOSEPH GILES recessed privacy flush pull sets is 44mm.

Available in PBW, MABW, DBZW, PSS, SSS.

Sliding Door – Claw Style Privacy



PRIVACY LOCK - SLIDING DOORS 57mm

LA1022.01 – Privacy lock for a sliding door. Expanding claw style catch. **57mm backset.** Case size 76d x 76h x 15mm. Forend 26 x 134mm and strike 26 x 96mm. Minimum door thickness when used with JG privacy flush pulls is 44mm.

PRIVACY LOCK - SLIDING DOORS 82mm

LA1022.02 – Privacy lock for a sliding door. Expanding claw style catch. **82mm backset.** Case size 101d x 76h x 15mm. Forend 26 x 134mm and strike 26 x 96mm.

This sliding door lock is recessed into the door and the dead-bolt is operated by a privacy thumb-turn from the inside and emergency release from the outside. When the thumb-turn is rotated, the bolt splays out sideways.

These locks are usually installed on doors that lead into a powder-room, bathroom or WC. The thumb-turn snib and emergency release will need to be compatible with a 5mm square spindle.

Minimum door thickness when used with JOSEPH GILES recessed privacy flush pull sets is 44mm.

When installing these locks, please ensure that the cut-out in the frame for the bolt is wide enough to house the splayed-out dead-bolt. It is essential that these locks and the associated recessed fittings are fitted with a high degree of precision.

Available in PBW, MABW, DBZW, PSS, SSS.

Double Doors – Fixing Passive Door



This lever action flush bolt is designed to be recessed vertically into the end or face of a door and is usually used to secure the slave door of a double door set; enabling the main door to latch or lock into the slave door. The bolt is thrown and retracted by operating the small lever.

We recommend that two bolts are fitted per door, one at the top of the door and one at the bottom. A 'receiver plate' is supplied with each bolt, which can be used for a bolt being fitted to the top of a door. A **BL1004 Floor Socket** is required for a bolt that is fitted at the bottom of the door and these need to be specified or purchased separately

Use this to fix the passive door of a double door in place at the top and bottom of the door. Choose a length that allows the user to comfortably reach the bolt to pull the lever to lock or unlock the door.

Use this on the edge face of the door for a truly minimal concealed look, or on the internal face for ease of access.

Available in the standard JOSEPH GILES metal finishes: PBW, BBW, PN, BN, CP, MABW, DBZW.

BL1001.01 – Lever action bolt recessed into the side or face to fix a door in position. Door bolt **152 x 19mm** with a 39mm x 19mm return. Supplied with a flat 19 x 38mm mortice.

BL1001.02 – Lever action bolt recessed into the side or face to fix a door in position. Door bolt **203 x 19mm** with a 39mm x 19mm return. Supplied with a flat 19 x 38mm mortice.

BL1001.03 – Lever action bolt recessed into the side or face to fix a door in position. Door bolt **254 x 19mm** with a 39mm x 19mm return. Supplied with a flat 19 x 38mm mortice.

BL1001.04 – Lever action bolt recessed into the side or face to fix a door in position. Door bolt **305 x 19mm** with a 39mm x 19mm return. Supplied with a flat 19 x 38mm mortice.

BL1001.05 – Lever action bolt recessed into the side or face to fix a door in position. Door bolt **457 x 19mm** with a 39mm x 19mm return. Supplied with a flat 19 x 38mm mortice.

BL1001.06 – Lever action bolt recessed into the side or face to fix a door in position. Door bolt **609 x 19mm** with a 39mm x 19mm return. Supplied with a flat 19 x 38mm mortice.

BL1001.07 – Lever action bolt recessed into the side or face to fix a door in position. Door bolt **762 x 19mm** with a 39mm x 19mm return. Supplied with a flat 19 x 38mm mortice.

BL1001.08 – Lever action bolt recessed into the side or face to fix a door in position. Door bolt **914 x 19mm** with a 39mm x 19mm return. Supplied with a flat 19 x 38mm mortice.

BL1004.01 Sprung loaded floor socket.
27mm dia. x 44mm long

Double Doors – Fixing Passive Door



BL1008.01 – Door bolt 150 x 43mm.

Surface-mounted bolt fixed through a backing plate. Supplied with a flat mortice plate and a raised bolt staple for differing installations. Usually used to secure the fixed door in a pair.

BL1008.02 – Door bolt 200 x 43mm.

Surface-mounted bolt fixed through a backing plate. Supplied with a flat mortice plate and a raised bolt staple for differing installations. Usually used to secure the fixed door in a pair.

This solid brass surface-mounted bolt can be fitted vertically or horizontally onto the face of a door or window. It is usually used to secure the slave door of a double door set, enabling the main door to latch or lock into it.

The bolt is thrown and retracted by sliding the knob. We recommend that two bolts are fitted per door; one at the top of the door and one at the bottom.

These bolts are supplied with a raised bolt staple and a flat mortice plate to allow for differing installations.

Available in the standard JOSEPH GILES metal finishes: PBW, BBW, PN, BN, CP, MABW, DBZW.

Double Doors – Fixing Passive Door

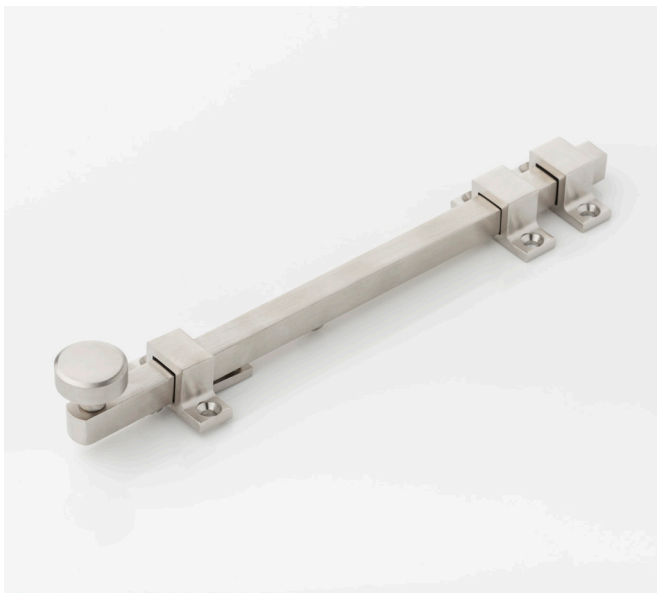

BL1009.01 – Skeleton bolt **150 x 34mm**.

Exposed bolt with screw-fixed saddle brackets. Supplied with a raised staple and a flat mortice plate.

BL1009.02 – Skeleton bolt **200 x 34mm**.

Exposed bolt with screw-fixed saddle brackets. Supplied with a raised staple and a flat mortice plate.

BL1009.03 – Skeleton bolt **300 x 34mm**.

Exposed bolt with screw-fixed saddle brackets. Supplied with a raised staple and a flat mortice plate.

BL1009.04 – Skeleton bolt **450 x 34mm**.

Exposed bolt with screw-fixed saddle brackets. Supplied with a raised staple and a flat mortice plate.

This solid brass surface-mounted skeleton bolt is usually fitted vertically onto the face of a door or window. It secures the slave door of a double door set to enable the main door to latch or lock into the slave door. Often used in conjunction with Cremona or Espagnolette bolts that have been fitted on to the main door.

The bolt is thrown and retracted by sliding the knob. We recommend that two bolts are fitted per door; one at the top of the door and one at the bottom.

Choose a length that allows the user to comfortably reach the knob to slide and unlock and lock the bolt.

These bolts are supplied with a raised bolt staple and a flat mortice plate to allow for differing installations.

Available in the standard JOSEPH GILES metal finishes: PBW, BBW, PN, BN, CP, MABW, DBZW.

Double Doors – Fixing Passive Door



BL1027.01 - 220mm recessed shoot-bolt is recessed within the door with a 27 x 100mm coverplate for the sliding operating lever situated on either the face or the edge of the door. Supplied with a flat 17 x 36mm mortice plate.

BL1027.02 - 600mm recessed shoot-bolt is recessed within the door with a 27 x 100mm coverplate for the sliding operating lever situated on either the face or the edge of the door. Supplied with a flat 17 x 36mm mortice plate.

BL1027.03 - 900mm recessed shoot-bolt is recessed within the door with a 27 x 100mm coverplate for the sliding operating lever situated on either the face or the edge of the door. Supplied with a flat 17 x 36mm mortice plate.

This recessed shoot-bolt is designed to secure the slave door on double door sets.

Place a pair at the top and bottom of the door and select a length that allows the user to comfortably reach the bolt to slide the lever to lock and unlock the bolt in place.

Please be advised that these bolts should only be installed with the floor sockets provided. They are not compatible with other sockets.

Available in the standard JOSEPH GILES metal finishes: PBW, BBW, PN, BN, CP, MABW, DBZW.

JOSEPH GILES

Hinges

JOSEPH GILES STAINLESS STEEL BUTT HINGES

(available with intumescent pads)

FINISHES



HG1007.01	Butt hinge. 316 stainless steel with button tip. 101x76x3mm Min door 35mm	PSS, SSS
HG1007.02	Butt hinge. 316 stainless steel with button tip. 101x89x3mm Min door 44mm	PSS, SSS
HG1007.03	Butt hinge. 316 stainless steel with button tip. 101x102x3mm Min door 44mm	PSS, SSS

JOSEPH GILES STAINLESS STEEL BUTT HINGES WITH SCREW COVER CAPS

(available with intumescent pads)



HG1040.01	Premium stainless steel butt hinge with screw cover cap 101x74x3mm	PSS, SSS, PN, BN
-----------	--	------------------

JOSEPH GILES PLAIN BRASS BUTT HINGES





HG1003.01	Butt hinge. Solid brass with bronze washer bearings. 75x50x3mm	PBW, BBW, PC, PN, BN, MABW, DBZW
HG1003.02	Butt hinge. Solid brass with bronze washer bearings. 100x65x3.5mm	PBW, BBW, PC, PN, BN, MABW, DBZW
HG1003.03	Butt hinge. Solid brass with bronze washer bearings. 100x75x4mm	PBW, BBW, PC, PN, BN, MABW, DBZW

JOSEPH GILES DECORATIVE BRASS BUTT HINGES



HG1010.01	Decorative butt hinge with ball finials. Solid brass with concealed bearing. 100x89x3.5mm	PBW, BBW, PC, PN, BN, MABW, DBZW
-----------	---	----------------------------------

	HG1023.01	Decorative butt hinge with stepped finials. Solid brass with concealed bearing. 100x88x3.5mm	PBW, BBW, PC, PN, BN, MABW, DBZW
	HG1035.01	Decorative butt hinge with decorative finials. Solid brass with concealed bearing. 100x89x3.5mm	PBW, BBW, PC, PN, BN, MABW, DBZW
	HG1038.01	Decorative butt hinge with button tip. Solid brass with concealed bearing. 100x76x3.5mm	PBW, BBW, PC, PN, BN, MABW, DBZW
	HG1038.02	Decorative butt hinge with button tip. Solid brass with concealed bearing. 100x89x3.5mm	PBW, BBW, PC, PN, BN, MABW, DBZW
	HG1038.03	Decorative butt hinge with button tip. Solid brass with concealed bearing. 100x102x3.5mm	PBW, BBW, PC, PN, BN, MABW, DBZW

JOSEPH GILES PROJECTION HINGES

	HG1011.01	Projection butt hinge. Solid brass with bronze washer bearings. 100x100x4mm	PBW, BBW, PC, PN, BN, MABW, DBZW
	HG1011.02	Projection butt hinge. Solid brass with bronze washer bearings. 100x125x5mm	PBW, BBW, PC, PN, BN, MABW, DBZW
	HG1011.03	Projection butt hinge. Solid brass with bronze washer bearings. 100x150x5mm	PBW, BBW, PC, PN, BN, MABW, DBZW
	HG1011.04	Projection butt hinge. Solid brass with bronze washer bearings. 100x200x5mm	PBW, BBW, PC, PN, BN, MABW, DBZW

JOSEPH GILES

JOSEPH GILES RISING BUTT HINGES



HG1041.01	Rising butt hinge (Right-hand) Solid brass 92x77x3mm 10.5mm rise	PBW, BBW, PC, PN, BN, MABW, DBZW
HG1042.01	Rising butt hinge (Left-hand) Solid brass 92x77x3mm 10.5mm rise	PBW, BBW, PC, PN, BN, MABW, DBZW

JOSEPH GILES PARLIAMENT HINGES



HG1012.01	Parliament projection hinge. Solid brass 102x102x4mm for doors to 25 kg.	PBW, BBW, PC, PN, BN, MABW, DBZW
HG1012.01	Parliament projection hinge. Solid brass 102x127x5mm for doors to 30 kg.	PBW, BBW, PC, PN, BN, MABW, DBZW
HG1012.01	Parliament projection hinge. Solid brass 102x152x5mm for doors to 35 kg.	PBW, BBW, PC, PN, BN, MABW, DBZW

JOSEPH GILES CABINET HINGES



HG1021.02	Decorative cabinet hinge. Solid brass with button tip. 50x38x2.5mm	PBW, BBW, PC, PN, BN, MABW, DBZW
HG1021.04	Decorative cabinet hinge. Solid brass with button tip. 63x50x2.5mm	PBW, BBW, PC, PN, BN, MABW, DBZW



HG1022.02	Decorative cabinet hinge. Solid brass with ball finial. 50x38x2.5mm	PBW, BBW, PC, PN, BN, MABW, DBZW
HG1022.04	Decorative cabinet hinge. Solid brass with ball finial. 63x50x2.5mm	PBW, BBW, PC, PN, BN, MABW, DBZW

Euro Key Cylinders

CHROME

TR2052 PC	Euro cylinder and turn 60mm 5 pin in Polished Chrome
TR2086 PC	Euro cylinder and turn 70mm 6 pin in Polished Chrome
TR2047 PC	Euro double key cylinder 60mm 5 pin in Polished Chrome
TR2076 PC	Euro double key cylinder 70mm 6 pin in Polished Chrome

POLISHED NICKEL

TR6127 PN	Euro cylinder and turn 60mm 5 pin in Polished Nickel
TR6129 PN	Euro cylinder and turn 70mm 6 pin in Polished Nickel
TR6126 PN	Euro double key cylinder 60mm 5 pin in Polished Nickel
TR6128 PN	Euro double key cylinder 70mm 6 pin in Polished Nickel

SATIN NICKEL

TR6123 SN	Euro cylinder and turn 60mm 5 pin in Satin Nickel
TR6125 SN	Euro cylinder and turn 70mm 6 pin in Satin Nickel
TR6122 SN	Euro double key cylinder 60mm 5 pin in Satin Nickel
TR6124 SN	Euro double key cylinder 70mm 6 pin in Satin Nickel

POLISHED BRASS

TR2050 PB	Euro cylinder and turn 60mm 5 pin in Polished Brass
TR2081 PB	Euro cylinder and turn 70mm 6 pin in Polished Brass
TR2045 PB	Euro double key cylinder 60mm 5 pin in Polished Brass
TR2071 PB	Euro double key cylinder 70mm 6 pin in Polished Brass

SATIN BRASS

TR6131 SB	Euro cylinder and turn 60mm 5 pin in Satin Brass
TR6133 SB	Euro cylinder and turn 70mm 6 pin in Satin Brass
TR6130 SB	Euro double key cylinder 60mm 5 pin in Satin Brass
TR6132 SB	Euro double key cylinder 70mm 6 pin in Satin Brass

ANTIQUÉ BRASS

TR2054 AB	Euro cylinder and turn 60mm 5 pin in Antique Brass
TR2082 AB	Euro cylinder and turn 70mm 6 pin in Antique Brass
TR2049 AB	Euro double key cylinder 60mm 5 pin in Antique Brass
TR2072 AB	Euro double key cylinder 70mm 6 pin in Antique Brass

MATT BLACK

TR2056 MB	Euro cylinder and turn 60mm 5 pin in Matt Black
TR2088 MB	Euro cylinder and turn 70mm 6 pin in Matt Black
TR2055 MB	Euro double key cylinder 60mm 5 pin in Matt Black
TR2078 MB	Euro double key cylinder 70mm 6 pin in Matt Black

THE ENGLISH TAPWARE COMPANY

170 QUEEN ST, WOOLLAHRA, SYDNEY 2025 • 751 HIGH ST, ARMADALE, MELBOURNE 3143 • www.englishtapware.com.au
